

NYC0102BLT1G

Sensitive Gate Silicon Controlled Rectifiers Reverse Blocking Thyristors

Designed and tested for highly-sensitive triggering in low-power switching applications.

Features

- High dv/dt
- Gating Current < 200 μ A
- Miniature SOT-23 Package for High Density PCB
- SZ Prefix for Automotive and Other Applications Requiring Unique Site and Control Change Requirements; AEC-Q101 Qualified and PPAP Capable
- These Devices are Pb-Free, Halogen Free/BFR Free and are RoHS Compliant

MAXIMUM RATINGS ($T_J = 25^\circ\text{C}$ unless otherwise noted)

Rating	Symbol	Value	Unit
Peak Repetitive Off-State Voltage (Note 1) ($R_{GK} = 1\text{K}$, $T_J = -40$ to $+110^\circ\text{C}$, Sine Wave, 50 to 60 Hz)	V_{DRM} , V_{RRM}	200	V
On-State Current RMS (180° Conduction Angle, $T_C = 80^\circ\text{C}$)	$I_{T(RMS)}$	0.25	A
Peak Non-repetitive Surge Current, $T_A = 25^\circ\text{C}$, (1/2 Cycle, Sine Wave, 60 Hz)	I_{TSM}	7.0	A
Circuit Fusing Considerations ($t = 8.3$ ms)	I^2t	0.2	A^2s
Forward Peak Gate Power (Pulse Width ≤ 1.0 μsec , $T_A = 25^\circ\text{C}$)	P_{GM}	0.1	W
Forward Average Gate Power ($t = 8.3$ msec, $T_A = 25^\circ\text{C}$)	$P_{G(AV)}$	0.02	W
Forward Peak Gate Current (Pulse Width ≤ 20 μs , $T_A = 25^\circ\text{C}$)	I_{FGM}	0.5	A
Reverse Peak Gate Voltage (Pulse Width ≤ 1.0 μs , $T_A = 25^\circ\text{C}$)	V_{RGM}	8.0	V
Operating Junction Temperature Range @ Rated V_{RRM} and V_{DRM}	T_J	-40 to +125	$^\circ\text{C}$
Storage Temperature Range	T_{stg}	-40 to +150	$^\circ\text{C}$

THERMAL CHARACTERISTICS

Characteristic	Symbol	Max	Unit
Total Device Dissipation FR-5 Board $T_A = 25^\circ\text{C}$	P_D	225	mW
Thermal Resistance, Junction-to-Ambient	$R_{\theta JA}$	380	$^\circ\text{C/W}$

Stresses exceeding those listed in the Maximum Ratings table may damage the device. If any of these limits are exceeded, device functionality should not be assumed, damage may occur and reliability may be affected.

1. V_{DRM} and V_{RRM} for all types can be applied on a continuous basis. Ratings apply for zero or negative gate voltage; however, positive gate voltage shall not be applied concurrent with negative potential on the anode. Blocking voltages shall not be tested with a constant current source such that the voltage ratings of the devices are exceeded.



Expertise Applied | Answers Delivered

Littelfuse.com

0.25 AMP, 200 VOLT SCRs

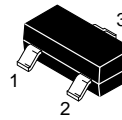

SOT-23
CASE 318
STYLE 8

MARKING DIAGRAM

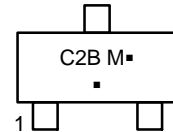

C2B = Specific Device Code
M = Date Code*
▪ = Pb-Free Package

(Note: Microdot may be in either location)

*Date Code orientation and/or overbar may vary depending upon manufacturing location.

PIN ASSIGNMENT

Pin	Assignment
1	Cathode
2	Gate
3	Anode

ORDERING INFORMATION

Device	Package	Shipping
NYC0102BLT1G	SOT-23 (Pb-Free)	3000 / Tape & Reel
SZNYC0102BLT1G	SOT-23 (Pb-Free)	3000 / Tape & Reel

NYC0102BLT1G

ELECTRICAL CHARACTERISTICS (T_C = 25°C unless otherwise noted.)

Characteristic	Symbol	Min	Typ	Max	Unit
----------------	--------	-----	-----	-----	------

OFF CHARACTERISTICS

Peak Repetitive Forward Blocking Current (V _{DRM} = 200 V, R _{GK} = 1 kΩ)	T _C = 25°C	I _{DRM}	–	–	1.0	μA
	T _C = 125°C		–	–	100	μA
Peak Repetitive Reverse Blocking Current (V _{DRM} = 200 V, R _{GK} = 1 kΩ)	T _C = 25°C	I _{RDM}	–	–	1.0	μA
	T _C = 125°C		–	–	100	μA

ON CHARACTERISTICS

Peak Forward On-State Voltage (I _{TM} = 0.4 A, t _p < 1 ms, T _C = 25°C)	V _{TM}	–	–	1.7	V
Gate Trigger Current (V _D = 12 V, R _L = 100 Ω, T _C = 25°C)	I _{GT}	–	–	200	μA
Gate Trigger Voltage (V _D = 12 V, R _L = 100 Ω, T _C = 25°C)	V _{GT}	–	–	0.8	V
Holding Current (I _T = 50 mA, R _{GK} = 1 kΩ, T _C = 25°C)	I _H	–	–	6.0	mA
Gate Non-Trigger Voltage (V _D = V _{DRM} , R _L = 3.3 kΩ, T _C = 125°C)	V _{GD}	0.1	–	–	V
Latching Current (I _G = 1.0 mA, R _{GK} = 1 kΩ, T _C = 25°C)	I _L	–	–	7.0	mA
Gate Reverse Voltage (I _{RG} = 10 μA)	V _{RG}	8.0	–	–	V

DYNAMIC CHARACTERISTICS

Critical Rate of Rise of Off-State Voltage (R _{GK} = 1 kΩ, T _C = 125°C)	dv/dt	200	–	–	V/μs
Critical Rate of Rise of On-State Current (I _G = 2xI _{GT} 60 Hz, t _r < 100 ns, T _J = 125°C)	di/dt	–	–	50	A/μs

Voltage Current Characteristic of SCR

Symbol	Parameter
V _{DRM}	Peak Repetitive Off State Forward Voltage
I _{DRM}	Peak Forward Blocking Current
V _{RDM}	Peak Repetitive Off State Reverse Voltage
I _{RDM}	Peak Reverse Blocking Current
V _{TM}	Peak on State Voltage
I _H	Holding Current

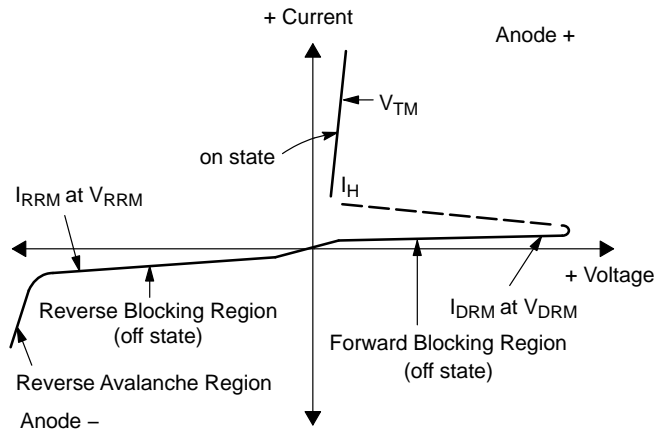

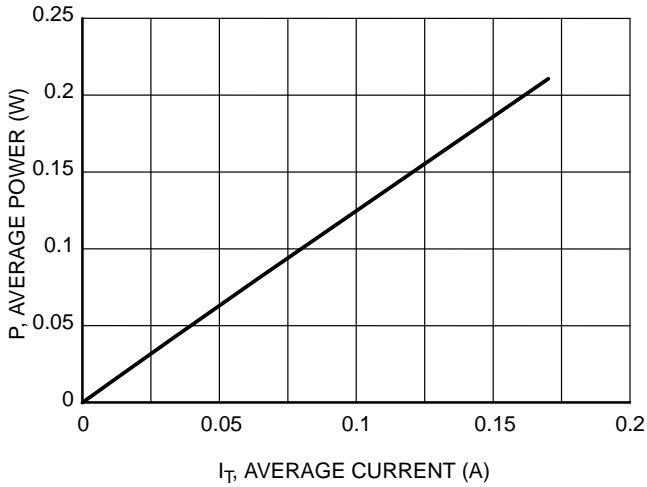

Figure 1. Maximum Average Power vs. Average Current

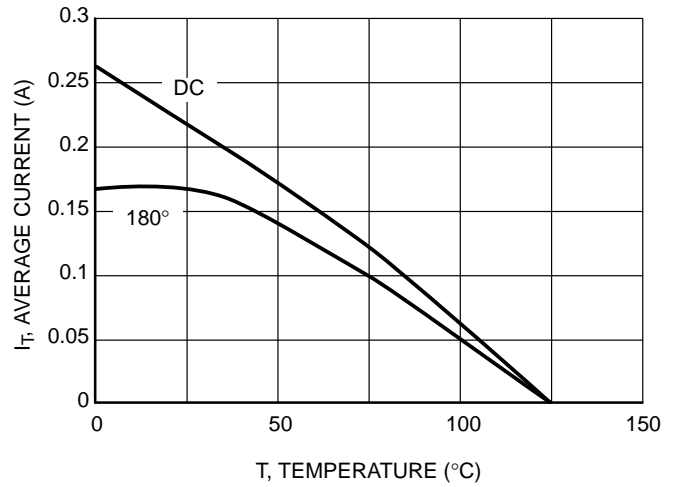

Figure 2. Current Derating

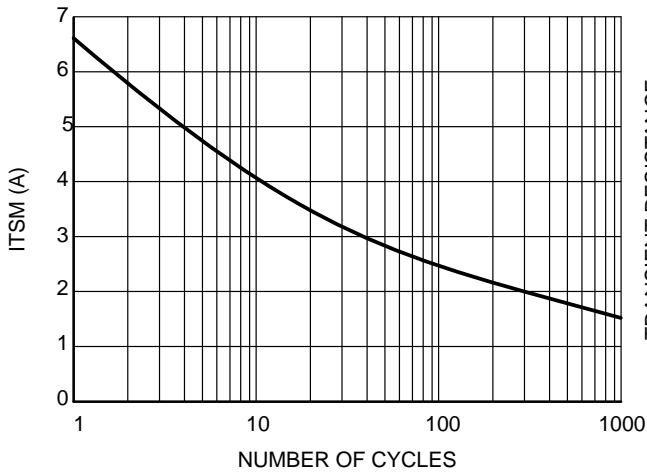

Figure 3. Surge Current ITSM vs. Number of Cycles

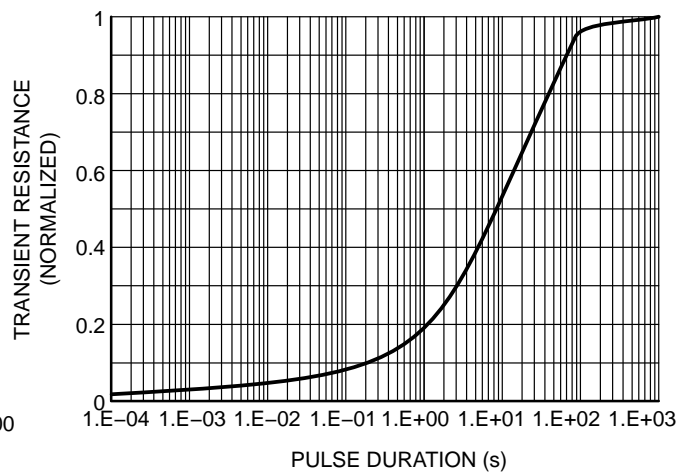

Figure 4. Thermal Response

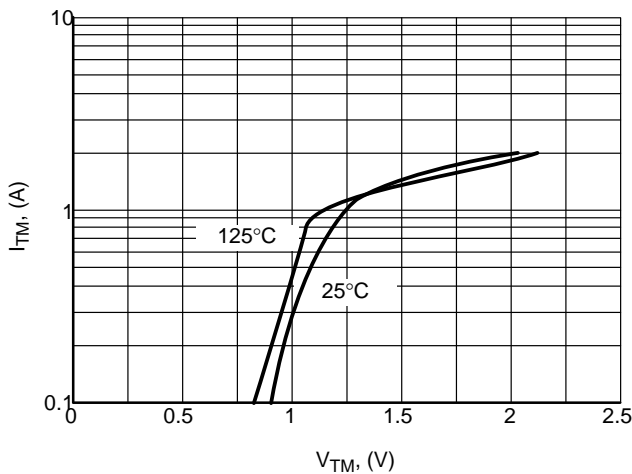

Figure 5. ON-State Characteristics

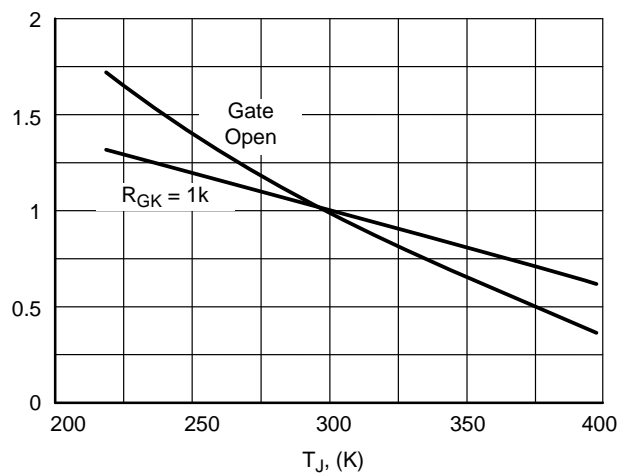
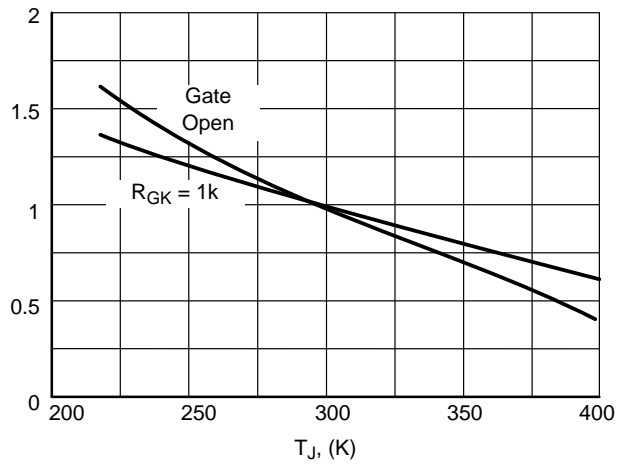

Figure 6. Gate Trigger Current vs. T_J (Normalized to 25°C)

NYC0102BLT1G



**Figure 7. Gate Trigger Current vs. T_J
(Normalized to 25°C)**

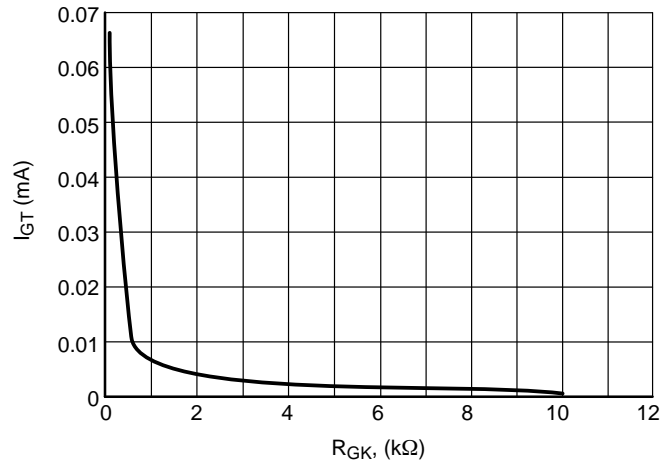

Figure 8. Gate Trigger Current vs. R_{GK}

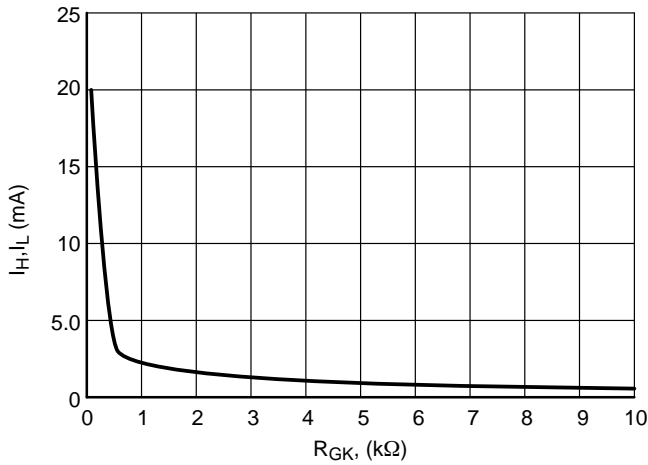

Figure 9. Holding and Latching Current vs. R_{GK}

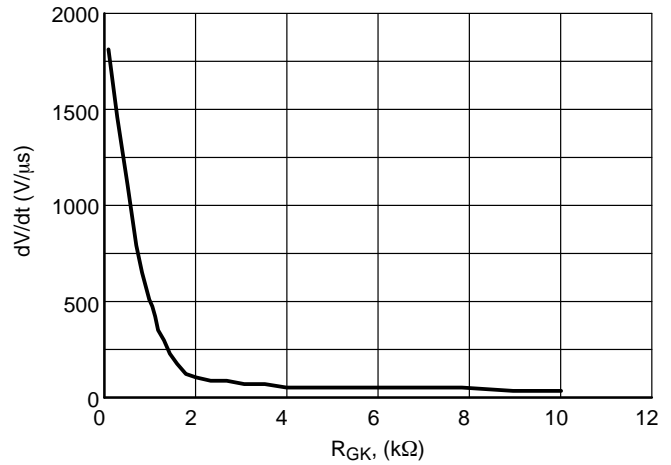

Figure 10. dV/dt vs. R_{GK}

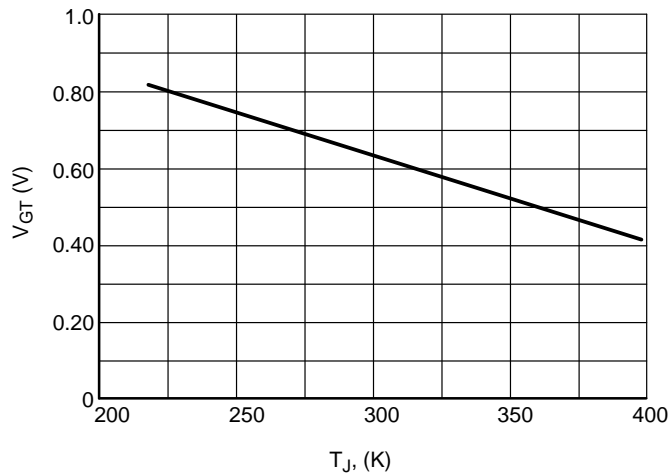
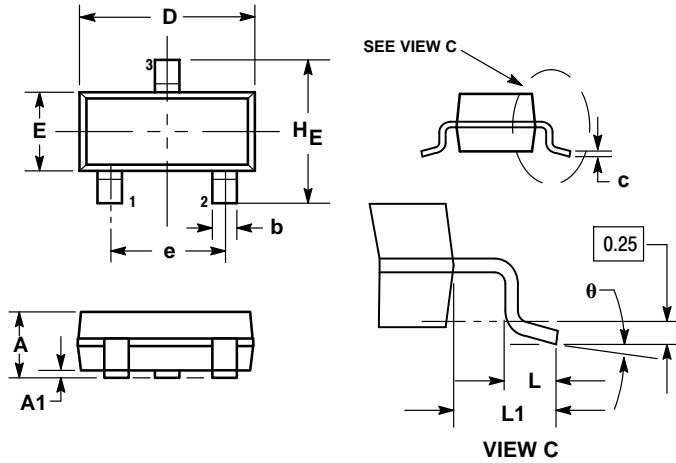

Figure 11. Gate Triggering Voltage vs. T_J

NYC0102BLT1G

PACKAGE DIMENSIONS

SOT-23 (TO-236)
CASE 318-08
ISSUE AP



- NOTES:
1. DIMENSIONING AND TOLERANCING PER ANSI Y14.5M, 1982.
 2. CONTROLLING DIMENSION: INCH.
 3. MAXIMUM LEAD THICKNESS INCLUDES LEAD FINISH THICKNESS. MINIMUM LEAD THICKNESS IS THE MINIMUM THICKNESS OF BASE MATERIAL.
 4. DIMENSIONS D AND E DO NOT INCLUDE MOLD FLASH, PROTRUSIONS, OR GATE BURRS.

DIM	MILLIMETERS			INCHES		
	MIN	NOM	MAX	MIN	NOM	MAX
A	0.89	1.00	1.11	0.035	0.040	0.044
A1	0.01	0.06	0.10	0.001	0.002	0.004
b	0.37	0.44	0.50	0.015	0.018	0.020
c	0.09	0.13	0.18	0.003	0.005	0.007
D	2.80	2.90	3.04	0.110	0.114	0.120
E	1.20	1.30	1.40	0.047	0.051	0.055
e	1.78	1.90	2.04	0.070	0.075	0.081
L	0.10	0.20	0.30	0.004	0.008	0.012
L1	0.35	0.54	0.69	0.014	0.021	0.029
HE	2.10	2.40	2.64	0.083	0.094	0.104
θ	0°	—	10°	0°	—	10°

STYLE 8:
PIN 1. ANODE
2. NO CONNECTION
3. CATHODE

SOLDERING FOOTPRINT

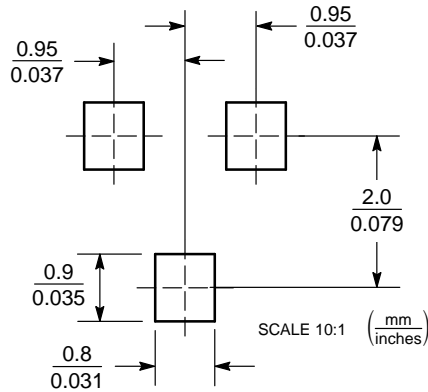

Littelfuse products are not designed for, and shall not be used for, any purpose (including, without limitation, automotive, military, aerospace, medical, life-saving, life-sustaining or nuclear facility applications, devices intended for surgical implant into the body, or any other application in which the failure or lack of desired operation of the product may result in personal injury, death, or property damage) other than those expressly set forth in applicable Littelfuse product documentation. Warranties granted by Littelfuse shall be deemed void for products used for any purpose not expressly set forth in applicable Littelfuse documentation. Littelfuse shall not be liable for any claims or damages arising out of products used in applications not expressly intended by Littelfuse as set forth in applicable Littelfuse documentation. The sale and use of Littelfuse products is subject to Littelfuse Terms and Conditions of Sale, unless otherwise agreed by Littelfuse.

Littelfuse.com