

4-Pin LED Lamp (7.6 mm)

OVFSxxC8

- Packaged in tubes
- Compatible with automatic placement equipment
- Compatible with infrared and vapor phase reflow solder process
- Mono-colors
- Pb-free

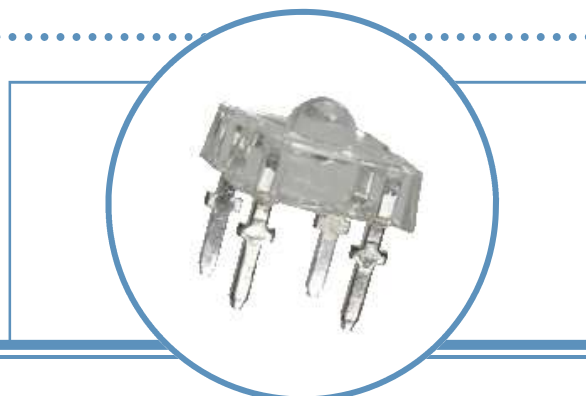

The **OVFSxxC8** series is designed with higher forward voltage to maximize brightness and incorporates a low-profile lens to enhance efficient light distribution. Response time is fast and it consumes less power resulting in low current requirements from circuit power supply. Tubular arrays replace neon in outdoor and indoor signs. This square package allows high-density arrays to form light engines.

Applications

- Automotive: Rear stop/turn signal lamps/truck marker lamps
- Mood-setting decoration and landscape lighting
 - Special decorative interior/exterior lighting
 - Special effects stage lighting
- Illumination for signs and channel letters
- Traffic signals, pedestrian and walkway signs

Part Number	DIM A	Beam Angle	Material	Emitted Color	Flux Typ. mlm	Lens Color
OVFSAAC8	[1.50] .059	100°	AllnGaP	Amber	8000	Clear
OVFSB7C8	[1.29] .051	70°	InGaN	Blue	2500	Clear
OVFSG7C8	[1.29] .051	70°	InGaN	Green	8500	Clear
OVFSRAC8	[1.50] .059	100°	AllnGaP	Red	8000	Clear
OVFSW6C8	[1.90] .075	60°	InGaN	White	7000	Clear

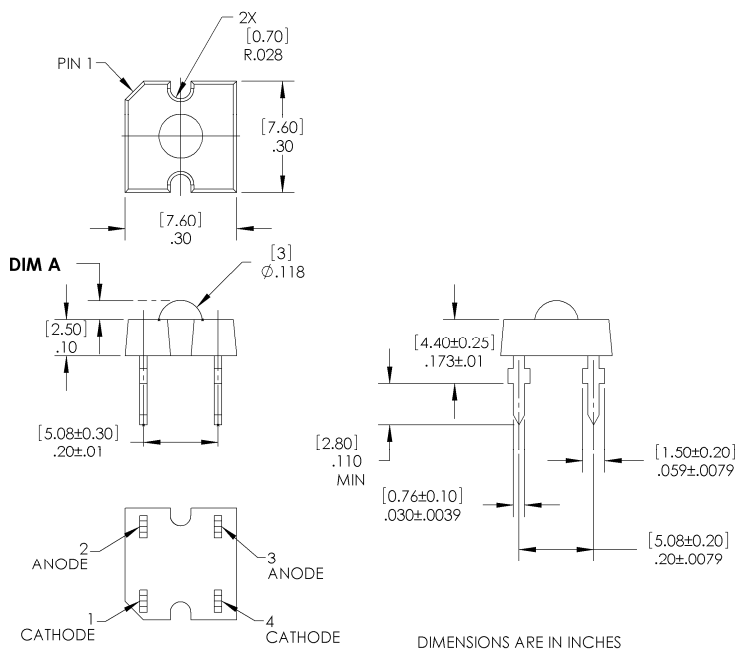

DO NOT LOOK DIRECTLY AT RED WITH UNSHIELDED EYES OR DAMAGE TO RETINA MAY OCCUR.

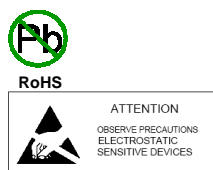

OPTEK reserves the right to make changes at any time in order to improve design and to supply the best product possible.

4-Pin LED Lamp

OVFSxxC8



Absolute Maximum Ratings $T_A = 25^\circ\text{C}$ unless otherwise noted

Storage Temperature Range	Blue, Green, Red, Amber, White	-40 ~ +100 °C
Operating Temperature Range	Blue, Green, Red, Amber	-40 ~ +100 °C
	White	-40 ~ +95 °C
Reverse Voltage		5 V
Continuous Forward Current	Blue, Green, White	35 mA
	Red, Amber	70 mA
Peak Forward Current (10% Duty Cycle, 1 kHz)	Blue, Green, White	100 mA
	Red, Amber	200 mA
Power Dissipation	Blue, Green, White	154 mW
	Red, Amber	210 mW
Lead Soldering Temperature (3mm from the base of the epoxy bulb)		260° C / 3 sec max
Electrostatic Discharge Classification (JEDE-JESD22-A114F)		Class 2

Optical and Electrical Characteristics ($T_A = 25^\circ\text{C}$)

SYMBOL	PARAMETER	COLOR	MIN	TYP	MAX	UNITS	CONDITIONS
Φ_v	Luminous Flux	Blue	1650	2500	----	mlm	$I_F = 30\text{ mA}$
		Green	5500	8500	----		
		White	3850	7000	----		
		Red	5500	8000	----		$I_F = 70\text{ mA}$
		Amber	6600	8000	----		
V_F	Forward Voltage	Blue & Green	----	3.6	4.4	V	$I_F = 30\text{ mA}$
		White	----	3.6	4.4		$I_F = 70\text{ mA}$
		Red, Amber	----	2.5	3.0		
I_R	Reverse Current	Blue & Green	----	----	100	μA	$V_R = 5\text{ V}$
		White					
		Red, Amber					
λ_D	Dominant Wavelength	Blue	460	470	475	nm	$I_F = 30\text{ mA}$
		Green	515	527	535		$I_F = 70\text{ mA}$
		Red	620	628	637		
		Amber	584	591	599		
x	Chromaticity Coordinates White			0.2895			$I_F = 30\text{ mA}$
y				0.2905			
$2\Theta_{1/2}\text{H-H}$	50% Power Angle	Blue & Green	----	70	----	deg	$I_F = 30\text{ mA}$
		White	----	60	----		$I_F = 70\text{ mA}$
		Red, Amber	----	100	----		

OPTEK reserves the right to make changes at any time in order to improve design and to supply the best product possible.

4-Pin LED Lamp

OVFSxxC8



Standard Bins

LEDs are sorted to luminous flux (Φ), luminous intensity (I_v), forward voltage (V_F), and dominant wavelength (λ_D) bins shown. Each tube will consist of a single intensity bin, forward voltage bin and dominant wavelength bin. Orders may be filled with any of the intensity bins or color bins listed in the following tables. Optek will not accept orders for single intensity bins or single color bins.

Luminous Intensity (I_v) @ 30mA

Blue: OVFSB7C8		
IV Code	Min (mIm)	Max (mIm)
F0	1650	2220
G0	2200	2750
H0	2750	3300
Green: OVFSG7C8		
IV Code	Min (mIm)	Max (mIm)
M0	5500	6600
N0	6600	8730
P0	8730	11,000
Q0	11,000	13,200

Forward Voltage (V_F) @ 30mA

BLUE: OVFSB7C8 & GREEN: OVFSG7C8		
VF Code	Min (V)	Max (V)
27	2.8	3.0
28	3.0	3.2
29	3.2	3.4
2a	3.4	3.6
2b	3.6	3.8
2c	3.8	4.0
2d	4.0	4.2
2e	4.2	4.4

Dominant Wavelength (nm)

Blue: OVFSB7C8		
nm Code	Min (nm)	Max (nm)
B3	460	465
B4	465	470
B5	470	475
Green: OVFSG7C8		
nm Code	Min (nm)	Max (nm)
G6	515	520
G7	520	525
G8	525	530
G9	530	535

Luminous Intensity (I_v) @ 70mA

Amber: OVFSAAC8		
IV Code	Min (mIm)	Max (mIm)
N0	6600	8730
P0	8730	11,000
Q0	11,000	13,200
Red: OVFSRAC8		
IV Code	Min (mIm)	Max (mIm)
M0	5500	6600
N0	6600	8730
P0	8730	11,000
Q0	11,000	13,200

Forward Voltage (V_F) @ 70mA

Amber: OVFSAAC8 & Red: OVFSRAC8		
VF Code	Min (V)	Max (V)
23	2.0	2.2
24	2.2	2.4
25	2.4	2.6
26	2.6	2.8
27	2.8	3.0

Dominant Wavelength (nm)

Amber: OVFSAAC8		
nm Code	Min (nm)	Max (nm)
A3	587	590
A4	590	593
A5	593	596
Red: OVFSRAC8		
nm Code	Min (nm)	Max (nm)
RE	620	637

OPTEK reserves the right to make changes at any time in order to improve design and to supply the best product possible.

4-Pin LED Lamp

OVFSxxC8



Standard Bins ($I_F = 30 \text{ mA}$)

LEDs are sorted to luminous flux (Φ), forward voltage (V_F), and chromaticity coordinates (x,y) bins shown. Each tube will consist of a single intensity bin, forward voltage bin, and chromaticity bin. Orders may be filled with any of the intensity bins or color bins listed in the following tables. Optek will not accept orders for single intensity bins or single color bins.

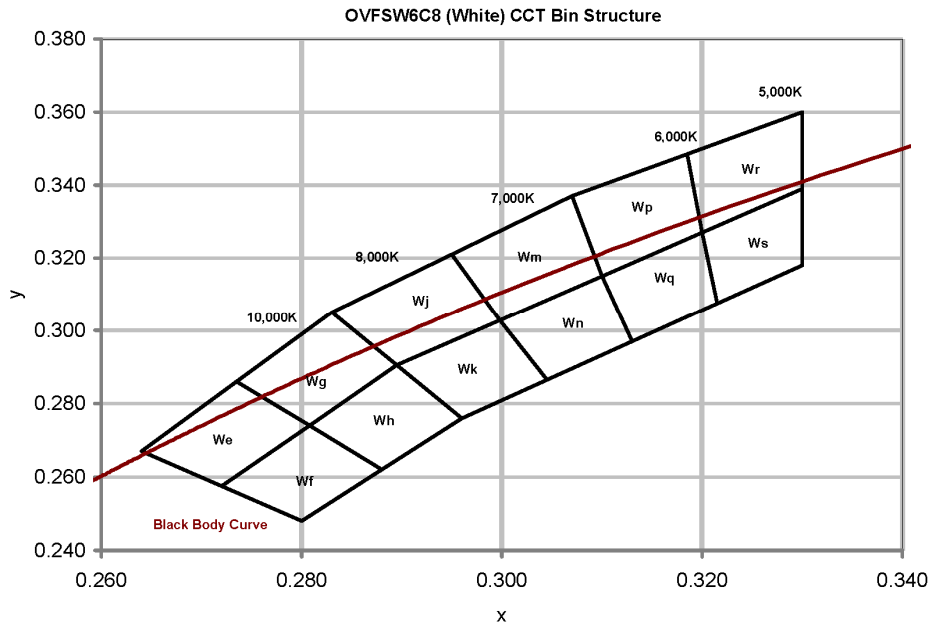

Φ	Luminous Flux	
	Bin	Min (lm) Max (lm)
M0	5500	6600
N0	6600	8730
P0	8730	11,000

V _F	Forward Voltage	
	Bin	Min (V) Max (V)
27	2.8	3.0
28	3.0	3.2
29	3.2	3.4
2a	3.4	3.6
2b	3.6	3.8
2c	3.8	4.0
2d	4.0	4.2
2e	4.2	4.4

Chromaticity Coordinates (x, y)

Rank	We				Wf				Wg				Wh			
	Cx	0.2640	0.2735	0.2808	0.2720	0.2720	0.2808	0.2880	0.2800	0.2735	0.2830	0.2895	0.2808	0.2808	0.2895	0.2960
Cy	0.2670	0.2860	0.2740	0.2575	0.2575	0.2740	0.2620	0.2480	0.2860	0.3050	0.2905	0.2740	0.2740	0.2905	0.2760	0.2620
Rank	Wj				Wk				Wm				Wn			
	Cx	0.2830	0.2950	0.2998	0.2895	0.2895	0.2998	0.3045	0.2960	0.2950	0.3070	0.3100	0.2998	0.2998	0.3100	0.3130
Cy	0.3050	0.3210	0.3028	0.2905	0.2905	0.3028	0.2865	0.2760	0.3210	0.3370	0.3150	0.3028	0.3028	0.3150	0.2970	0.2865
Rank	Wp				Wq				Wr				Ws			
	Cx	0.3070	0.3185	0.3200	0.3100	0.3100	0.3215	0.3130	0.3185	0.3300	0.3300	0.3200	0.3200	0.3200	0.3300	0.3300
Cy	0.3370	0.3485	0.3270	0.3150	0.3150	0.3270	0.3075	0.2970	0.3485	0.3600	0.3390	0.3270	0.3270	0.3390	0.3180	0.3075

OPTeK reserves the right to make changes at any time in order to improve design and to supply the best product possible.

4-Pin LED Lamp OVFSxxC8

Typical Electro-Optical Characteristics Curves — OVFSB7C8 (Blue) & OVFSG7C8 (Green)

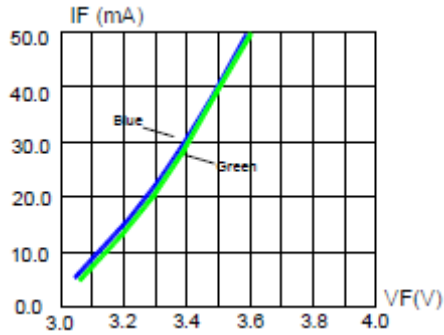

Forward Current vs Forward Voltage

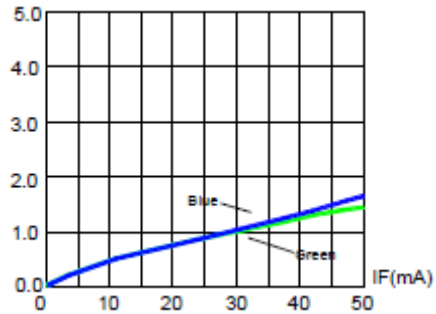

Relative Luminous Flux vs Forward Current

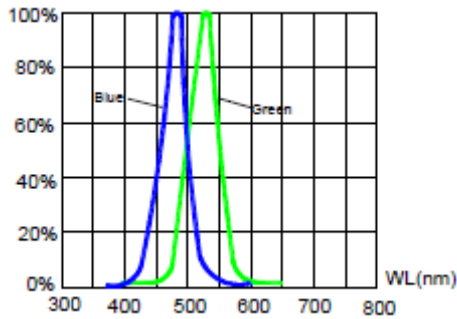

Relative Luminous Flux vs Wavelength

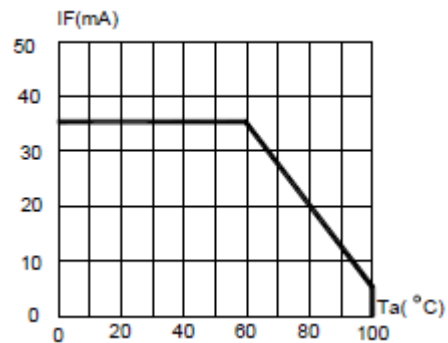

Maximum Forward DC Current vs Ambient Temperature

50% Power Angle: 70°

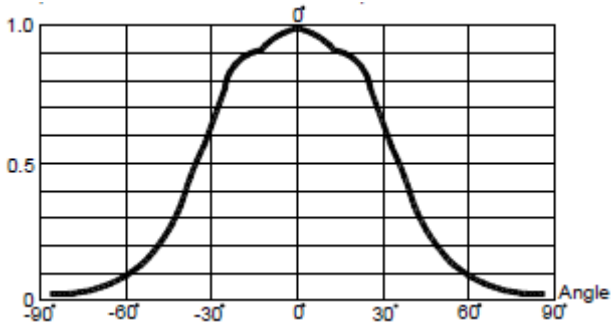

Angular Distribution

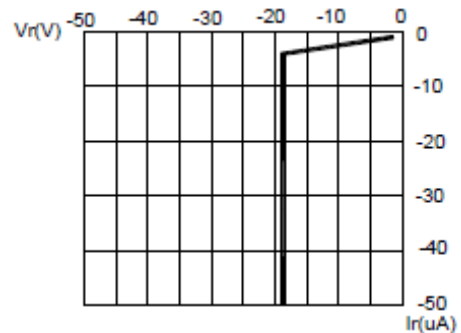

Reverse Current vs Reverse Voltage

OPTEK reserves the right to make changes at any time in order to improve design and to supply the best product possible.

Typical Electro-Optical Characteristics Curves — OVFSAAC8 (Amber) & OVFSRAC8 (Red)

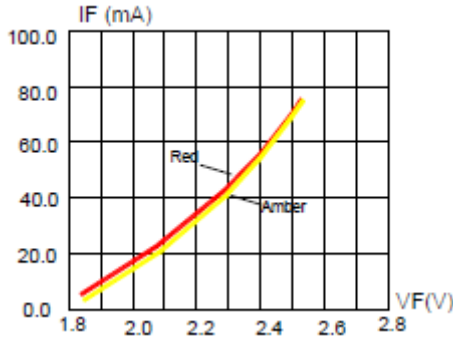

Forward Current vs Forward Voltage

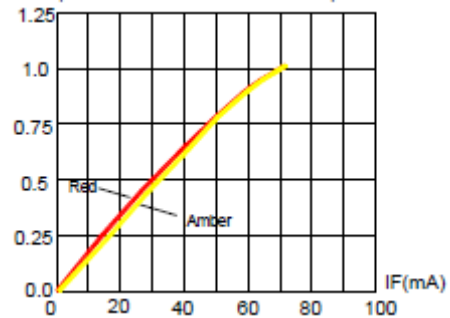

Relative Luminous Flux vs Forward Current

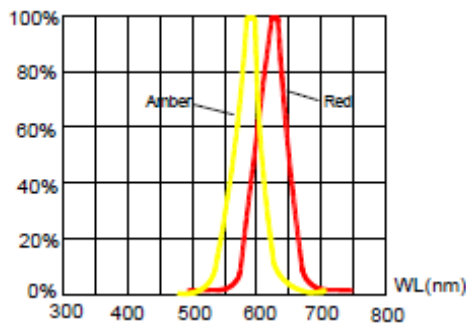

Relative Luminous Flux vs Wavelength

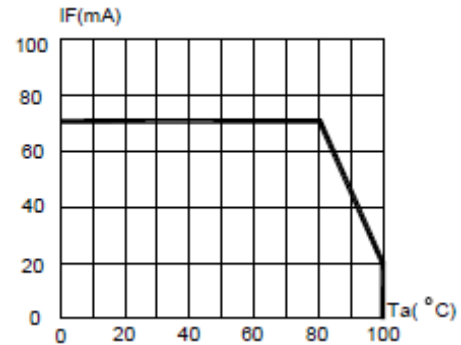

Maximum Forward DC Current vs Ambient Temperature

50% Power Angle: 100°

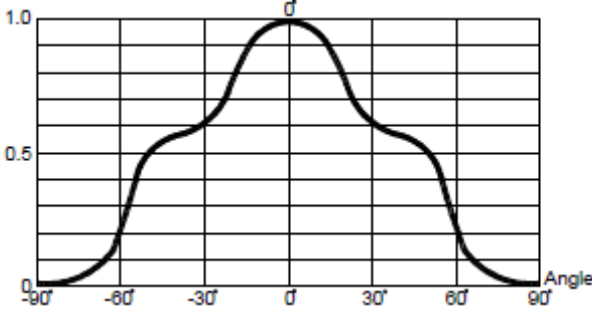

Angular Distribution

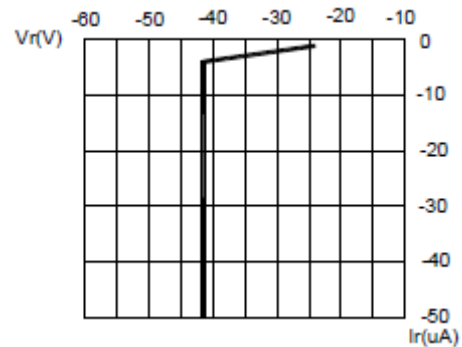

Reverse Current vs Reverse Voltage

OPTEK reserves the right to make changes at any time in order to improve design and to supply the best product possible.

Typical Electro-Optical Characteristics Curves — OVFSW6C8 (White)

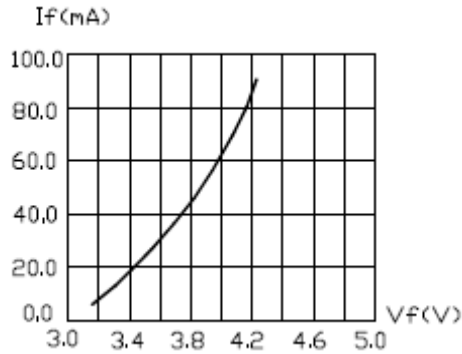

Forward Current vs Forward Voltage

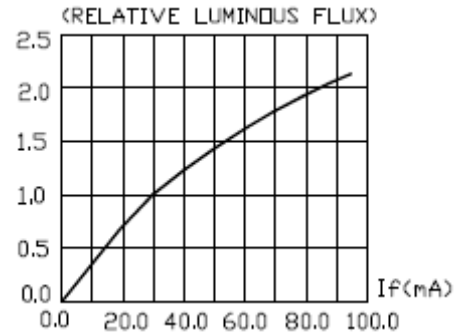

Relative Luminous Flux vs Forward Current

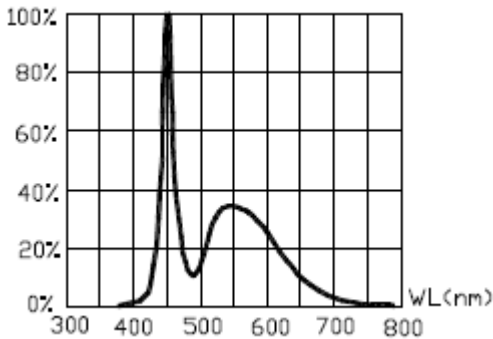

Relative Luminous Flux vs Wavelength

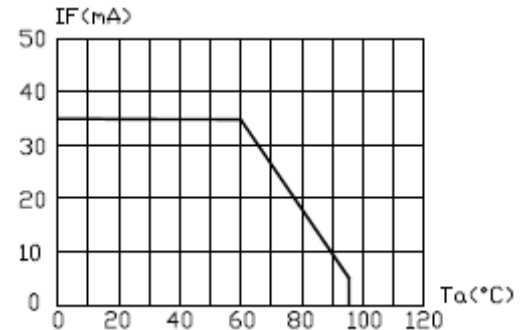

Maximum Forward DC Current vs Ambient Temperature

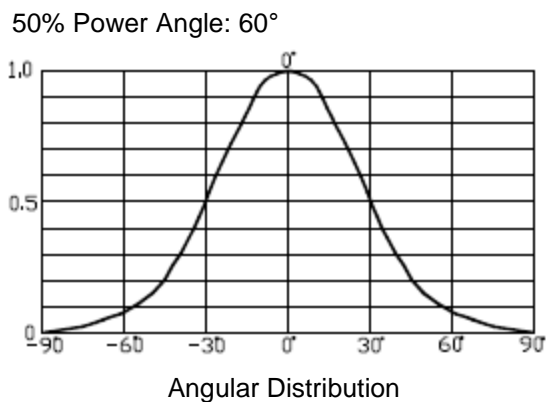

Angular Distribution

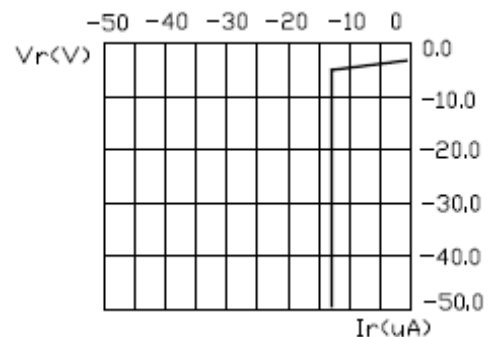

Reverse Current vs Reverse Voltage

OPTEK reserves the right to make changes at any time in order to improve design and to supply the best product possible.

Packaging

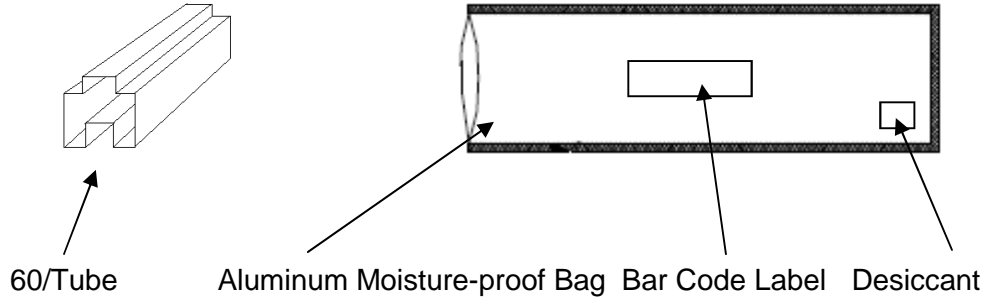

OPTEK reserves the right to make changes at any time in order to improve design and to supply the best product possible.