

EQW012/020/023/025 Series, Eighth-Brick Power Modules

36 - 75Vdc Input; 1.2Vdc to 5Vdc Output; 12A to 25A Output

RoHS Compliant



Applications

- Distributed power architectures
- Wireless Networks
- Enterprise Networks
- Optical and Access Network Equipment
- Latest generation IC's (DSP, FPGA, ASIC) and Microprocessor powered applications.

Options

- Remote On/Off logic (positive or negative)
- Surface Mount (-S Suffix)
- Short pins
- Alternative output voltage adjustment equations (1.2V output only, -V Suffix)

Description

The EQW series, Eighth-brick power modules are isolated dc-dc converters that can deliver up to 25A of output current and provide a precisely regulated output voltage over a wide range of input voltages ($V_i = 36 - 75\text{Vdc}$). The modules achieve full load efficiency of 88% at 3.3V output voltage. The open frame modules construction, available in both surface-mount and through-hole packaging, enable designers to develop cost- and space-efficient solutions. Standard features include remote On/Off, remote sense, output voltage adjustment, overvoltage, overcurrent and overtemperature protection.

* UL is a registered trademark of Underwriters Laboratories, Inc.

† CSA is a registered trademark of Canadian Standards Association.

‡ VDE is a trademark of Verband Deutscher Elektrotechniker e.V.

** ISO is a registered trademark of the International Organization of Standards

Features

- Compliant to RoHS EU Directive 2011/65/EU (Z versions)
- Compliant to RoHS EU Directive 2011/65/EU under exemption 7b (Lead solder exemption). Exemption 7b will expire after June 1, 2016 at which time this product will no longer be RoHS compliant (non-Z versions)
- Delivers up to 25A Output current
- High efficiency – 91% at 5.0Vdc full load ($V_{in}=48\text{Vdc}$)
- Low output ripple and noise
- Surface mount or through hole
- Industry standard Eight brick footprint 57.9mm x 22.8mm x 8.5mm(MAX) (2.28in x 0.9in x 0.335in)
- Constant switching frequency
- Remote On/Off Positive logic (primary referenced)
- Remote Sense
- Adjustable output voltage ($\pm 10\%$)
- Output overvoltage and overcurrent protection
- Input undervoltage lockout
- Output overcurrent and overvoltage protection
- Over-temperature protection
- Wide operating temperature range (-40°C to 85°C)
- UL* 60950-1 Recognized, CSA† C22.2 No. 60950-1-03 Certified, and VDE‡ 0805 (IEC60950, 3rd edition) Licensed
- ISO** 9001 and ISO14001 certified manufacturing facilities
- Meets the voltage and current requirements for ETSI 300-132-2 and complies with and licensed for Basic insulation rating per IEC60950 3rd edition

EQW012/020/023/025 Series, Eighth-Brick Power Modules

36 - 75Vdc Input; 1.2Vdc to 5Vdc Output; 12A to 25A Output

Absolute Maximum Ratings

Stresses in excess of the absolute maximum ratings can cause permanent damage to the device. These are absolute stress ratings only, functional operation of the device is not implied at these or any other conditions in excess of those given in the operations sections of the data sheet. Exposure to absolute maximum ratings for extended periods can adversely affect the device reliability.

Parameter	Device	Symbol	Min	Max	Unit
Input Voltage	EQW	V_{IN}	-0.3	80	V _{dc}
Continuous					
Transient (100ms)	EQW	$V_{IN,trans}$	-0.3	100	V _{dc}
Operating Ambient Temperature (see Thermal Considerations section)	All	T_A	-40	85	°C
Storage Temperature	All	T_{stg}	-55	125	°C
I/O Isolation Voltage (100% factory Hi-Pot tested)	All	—	—	1500	V _{dc}

Electrical Specifications

Unless otherwise indicated, specifications apply over all operating input voltage, resistive load, and temperature conditions.

Parameter	Device	Symbol	Min	Typ	Max	Unit
Operating Input Voltage	All	V_{IN}	36	48	75	V _{dc}
Maximum Input Current ($V_{IN}=0V$ to 75V, $I_o=I_{o,max}$)	All	$I_{IN,max}$			3	A _{dc}
Input No Load Current ($V_{in} = 48V_{dc}$, $I_o = 0$, module enabled)	All	$I_{IN,No\ load}$		75		mA
Input Stand-by Current ($V_{in} = 48V_{dc}$, module disabled)	All	$I_{IN,stand-by}$		3		mA
Inrush Transient	All	I^2t			1	A ² s
Input Reflected Ripple Current, peak-to-peak (5Hz to 20MHz, 12μH source impedance; $V_{IN}=0V$ to 75V, $I_o=I_{o,max}$; see Test Configuration section)	All			13		mA _{p-p}
Input Ripple Rejection (120Hz)	All			50		dB
EMC, EN55022			See EMC Considerations section			

CAUTION: This power module is not internally fused. An input line fuse must always be used.

This power module can be used in a wide variety of applications, ranging from simple standalone operation to an integrated part of a sophisticated power architecture. To preserve maximum flexibility, internal fusing is not included, however, to achieve maximum safety and system protection, always use an input line fuse. The safety agencies require a fast-acting fuse with a maximum rating of 6A (see Safety Considerations section). Based on the information provided in this data sheet on inrush energy and maximum dc input current, the same type of fuse with a lower rating can be used. Refer to the fuse manufacturer's data sheet for further information.

EQW012/020/023/025 Series, Eighth-Brick Power Modules

36 - 75Vdc Input; 1.2Vdc to 5Vdc Output; 12A to 25A Output

Electrical Specifications (continued)

Parameter	Device	Symbol	Min	Typ	Max	Unit
Output Voltage Set-point ($V_{IN}=V_{IN,nom}$, $I_O=I_{O,max}$, $T_{ref}=25^{\circ}C$)	1.2 Vdc	$V_{O,set}$	1.18	1.2	1.22	V _{dc}
	1.5 Vdc	$V_{O,set}$	1.47	1.5	1.53	V _{dc}
	1.8 Vdc	$V_{O,set}$	1.76	1.8	1.84	V _{dc}
	2.5V dc	$V_{O,set}$	2.45	2.5	2.55	V _{dc}
	3.3 Vdc	$V_{O,set}$	3.25	3.3	3.35	V _{dc}
	5.0 Vdc	$V_{O,set}$	4.90	5.0	5.10	V _{dc}
Output Voltage (Over all operating input voltage, resistive load, and temperature conditions until end of life)	1.2 Vdc	V_O	1.16	—	1.24	V _{dc}
	1.5 Vdc	V_O	1.45	—	1.55	V _{dc}
	1.8 Vdc	V_O	1.74	—	1.86	V _{dc}
	2.5V dc	V_O	2.42	—	2.57	V _{dc}
	3.3 Vdc	V_O	3.2	—	3.4	V _{dc}
	5.0 Vdc	V_O	4.85	—	5.15	V _{dc}
Adjustment Range Selected by external resistor	1.8Vdc	V_O	-10	—	+12	% $V_{O,set}$
	2.5Vdc	V_O	-10	—	+20	% $V_{O,set}$
	3.3Vdc	V_O	-20	—	+10	% $V_{O,set}$
	All others	V_O	-10.0	—	+10	% $V_{O,set}$
Output Regulation Line ($V_{IN}=V_{IN,min}$ to $V_{IN,max}$) Load ($I_O=I_{O,min}$ to $I_{O,max}$) Temperature ($T_{ref}=T_{A,min}$ to $T_{A,max}$)	All		—	—	0.1	% $V_{O,set}$
	All		—	—	10	mV
	All		—	0.2	—	% $V_{O,set}$
Output Ripple and Noise on nominal output measured with 10 μ F Tantalum, 1 μ F ceramic ($V_{IN}=V_{IN,nom}$ and $I_O=I_{O,min}$ to $I_{O,max}$)	5.0 Vdc		—	18	35	mV _{rms}
	5.0 Vdc		—	50	90	mV _{pk-pk}
	All others		—	8	20	mV _{rms}
	All others		—	40	75	mV _{pk-pk}
External Capacitance*	5.0 Vdc	$C_{O,max}$	0	—	3000	μ F
	All others	$C_{O,max}$	0	—	5000	μ F
Output Current	1.2 Vdc	I_O	0	—	25.0	A _{dc}
	1.5 Vdc	I_O	0	—	25.0	A _{dc}
	1.8 Vdc	I_O	0	—	25.0	A _{dc}
	2.5V dc	I_O	0	—	23.0	A _{dc}
	3.3 Vdc	I_O	0	—	20.0	A _{dc}
	5.0 Vdc	I_O	0	—	12.0	A _{dc}
Output Current Limit Inception ($V_O = 90\%$ of $V_{O,set}$)	1.2 Vdc	$I_{O,lim}$	—	35	—	A _{dc}
	1.5 Vdc	$I_{O,lim}$	—	35	—	A _{dc}
	1.8 Vdc	$I_{O,lim}$	—	35	—	A _{dc}
	2.5V dc	$I_{O,lim}$	—	30	—	A _{dc}
	3.3 Vdc	$I_{O,lim}$	—	25	—	A _{dc}
	5.0 Vdc	$I_{O,lim}$	—	15	—	A _{dc}

EQW012/020/023/025 Series, Eighth-Brick Power Modules
36 - 75Vdc Input; 1.2Vdc to 5Vdc Output; 12A to 25A Output

Electrical Specifications (continued)

Parameter	Device	Symbol	Min	Typ	Max	Unit
Output Short-circuit Current ($V_o = 0.25V$)	1.2 Vdc	$I_{o,sc}$	—	42	—	A _{dc}
	1.5 Vdc	$I_{o,sc}$	—	42	—	A _{dc}
	1.8 Vdc	$I_{o,sc}$	—	42	—	A _{dc}
	2.5V dc	$I_{o,sc}$	—	40	—	A _{dc}
	3.3 Vdc	$I_{o,sc}$	—	37	—	A _{dc}
	5.0 Vdc	$I_{o,sc}$	—	25	—	A _{dc}
Efficiency $V_{IN}=V_{IN, nom}, T_A=25^\circ C$ $I_o=I_{o, max}, V_o=V_{o, set}$	1.2 Vdc	η	—	81.0	—	%
	1.5 Vdc	η	—	81.0	—	%
	1.8 Vdc	η	—	84.0	—	%
	2.5V dc	η	—	87.0	—	%
	3.3 Vdc	η	—	88.0	—	%
	5.0 Vdc	η	—	91.0	—	%
Switching Frequency	All	f_{sw}	—	285	—	kHz
Dynamic Load Response ($\Delta I_o/\Delta t=0.1A/\mu s; V_{in}=V_{in, set}; T_A=25^\circ C$) Load Change from $I_o= 50\%$ to 75% of $I_{o, max}$; 100F Tantalum, 10F ceramic external capacitance Peak Deviation Settling Time ($V_o<10\%$ peak deviation)	All	V_{pk}	—	200	—	mV
	All	t_s	—	200	—	μs
	All	V_{pk}	—	200	—	mV
	All	t_s	—	200	—	μs

Isolation Specifications

Parameter	Symbol	Min	Typ	Max	Unit
Isolation Capacitance	C_{iso}	—	1000	—	pF
Isolation Resistance	R_{iso}	10	—	—	M Ω

General Specifications

Parameter	Device	Min	Typ	Max	Unit
Calculated Reliability Based upon Telcordia SR-332 Issue 2: Method I, Case 1, ($I_o=80\%I_{o, max}, T_A=40^\circ C,$ Airflow = 200 lfm), 90% confidence	MTBF	F-S	3,287,361		Hours
	FIT	F-S	304		10 ⁹ /Hours
Weight		—	15.2 (0.6)	—	g (oz.)

EQW012/020/023/025 Series, Eighth-Brick Power Modules

36 - 75Vdc Input; 1.2Vdc to 5Vdc Output; 12A to 25A Output

Feature Specifications

Unless otherwise indicated, specifications apply over all operating input voltage, resistive load, and temperature conditions. See Feature Descriptions for additional information.

Parameter	Device	Symbol	Min	Typ	Max	Unit
Remote On/Off Signal Interface ($V_{IN}=V_{IN,min}$ to $V_{IN,max}$; open collector or equivalent, Signal referenced to V_{IN} -terminal) Negative Logic: device code suffix "1" Logic Low = module On, Logic High = module Off Positive Logic: No device code suffix required Logic Low = module Off, Logic High = module On Logic Low Specification Remote On/Off Current – Logic Low	All	$I_{on/off}$	—	0.15	1.0	mA
On/Off Voltage: Logic Low	All	$V_{on/off}$	-0.7	—	1.2	V
Logic High – (Typ = Open Collector)	All	$V_{on/off}$	—	—	15	V
Logic High maximum allowable leakage current	All	$I_{on/off}$	—	—	10	μ A
Turn-On Delay and Rise Times ($V_I=48Vdc$, $I_O=I_{O,max}$, V_O to within $\pm 1\%$ of steady state) Case 1: On/Off input is set to Logic high and then input power is applied (delay from instant at which $V_I = V_{I,min}$ until $V_O = 10\%$ of V_O, set)	All	Tdelay	—	20	—	msec
Case 2: Input power is applied for at least one second and then the On/Off input is set to logic high (delay from instant at which $V_{on/off} = 0.9V$ until $V_O = 10\%$ of V_O, set)	All	Tdelay	—	12	—	msec
Output voltage Rise time (time for V_O to rise from 10% of V_O, set to 90% of V_O, set)	All	Trise	—	0.9	—	msec
Output voltage overshoot ($I_O = 80\%$ of $I_{O,max}$, $V_I = 48Vdc$ $T_A=25^\circ C$)	All	—	—	—	5	$\%V_{O,set}$
Output Voltage Remote Sense	1.2, 1.5, 1.8Vdc 2.5, 3.3, 5.0 Vdc	—	—	—	0.25 10	Vdc $\%V_{O,set}$
Output Overvoltage Protectionn (Clamp)	1.2 Vdc 1.5 Vdc 1.8 Vdc 2.5V dc 3.3 Vdc 5.0 Vdc	$V_{O, limit}$ $V_{O, limit}$ $V_{O, limit}$ $V_{O, limit}$ $V_{O, limit}$ $V_{O, limit}$	— — — — — —	2.0 2.3 2.3 3.1 4.0 6.1	2.8 3.2 3.2 3.7 4.6 7.0	Vdc Vdc Vdc Vdc Vdc Vdc
Overtemperature Protection (See thermal section)	All	T_{ref}	—	125	—	$^\circ C$
Input Undervoltage Lockout Turn-on Threshold	All	—	—	32	36	Vdc
Turn-off Threshold	All	—	25	27	—	Vdc

EQW012/020/023/025 Series, Eighth-Brick Power Modules

36 - 75Vdc Input; 1.2Vdc to 5Vdc Output; 12A to 25A Output

Characteristic Curves

The following figures provide typical characteristics for the EQW025A0P1 (1.2V, 25A) at 25°C. The figures are identical for either positive or negative Remote On/Off logic.

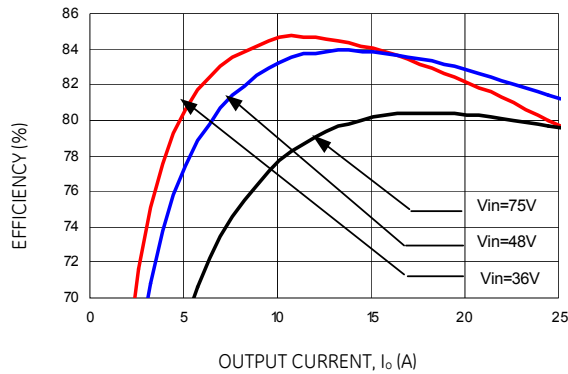

Figure 1. Typical Converter Efficiency Vs. Output current at Room Temperature.

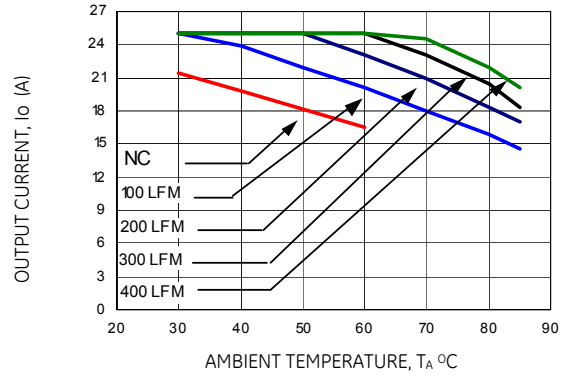

Figure 4. Derating Output Current versus Local Ambient Temperature and Airflow

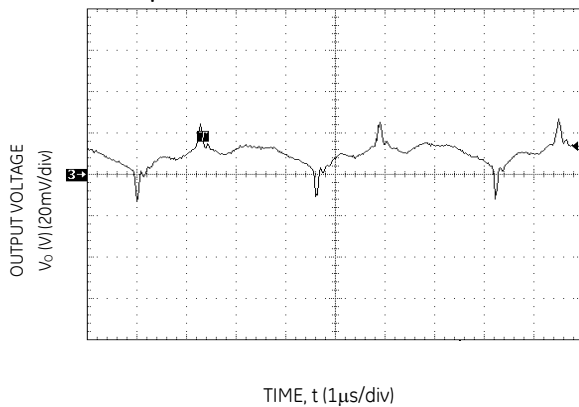

Figure 2. Typical Output Ripple and Noise (Vin = 48Vdc, Io = 25A).

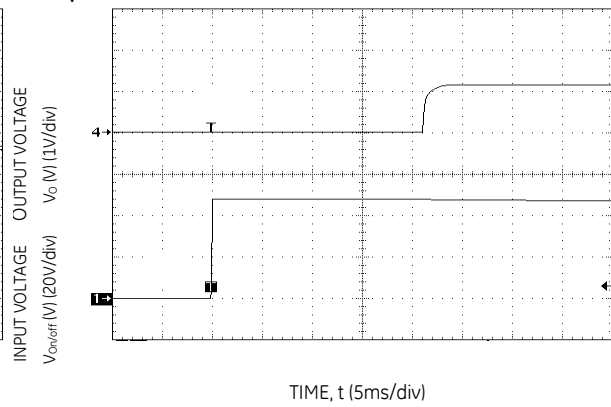

Figure 5. Typical Start-Up with application of Vin (Vin = 48Vdc, Io = 25A).

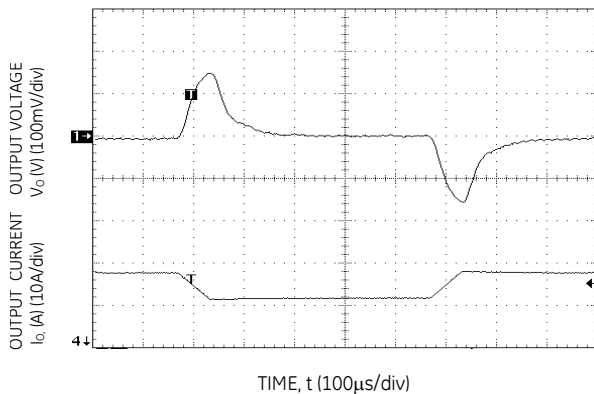

Figure 3. Typical Transient Response to Dynamic Load change Load from 50% to 75% to 50% of Full load at 48 Vdc Input.

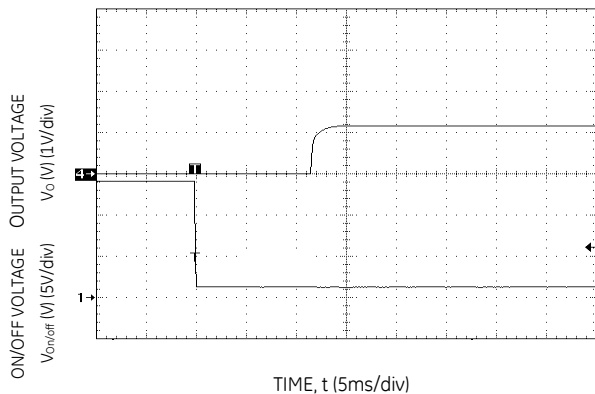

Figure 6. Typical Start-Up Using Remote On/Off, negative logic version shown (Vin = 48Vdc, Io = 25A).

EQW012/020/023/025 Series, Eighth-Brick Power Modules

36 - 75Vdc Input; 1.2Vdc to 5Vdc Output; 12A to 25A Output

Characteristic Curves (continued)

The following figures provide typical characteristics for the EQW025A0M (1.5V, 25A) at 25°C. The figures are identical for either positive or negative Remote On/Off logic.

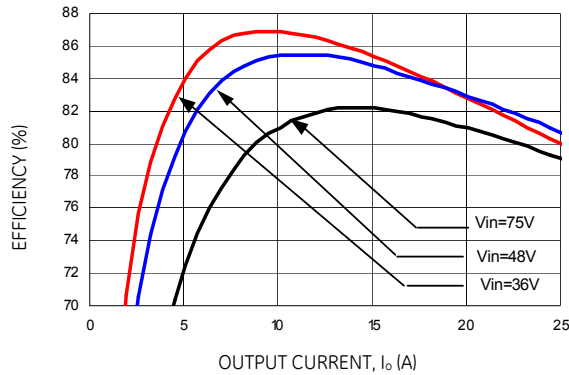

Figure 7. Typical Converter Efficiency Vs. Output current at Room Temperature.

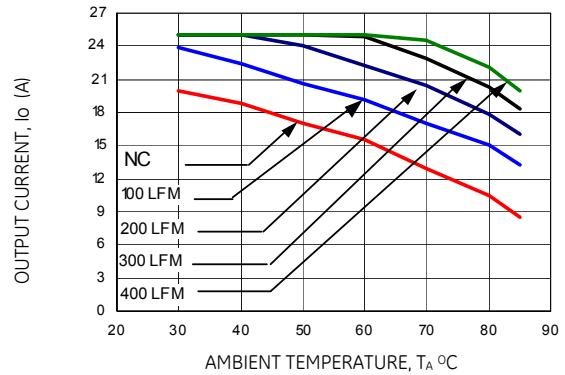

Figure 10. Derating Output Current versus Local Ambient Temperature and Airflow

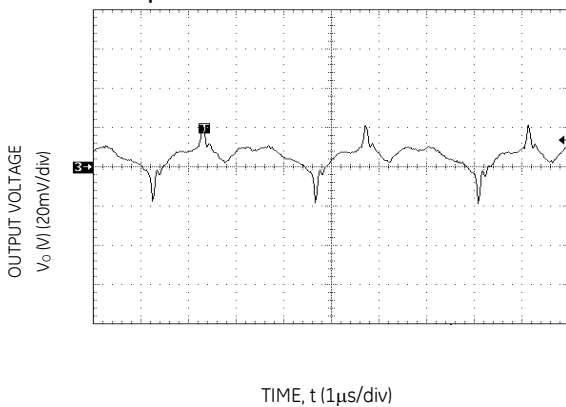

Figure 8. Typical Output Ripple and Noise (Vin = 48Vdc, Io = 25A).

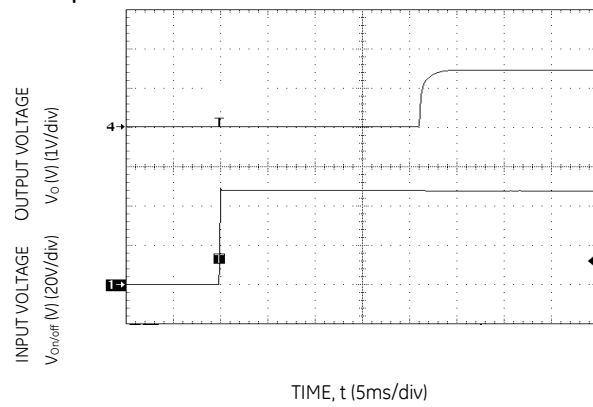

Figure 11. Typical Start-Up with application of Vin (Vin = 48Vdc, Io = 25A).

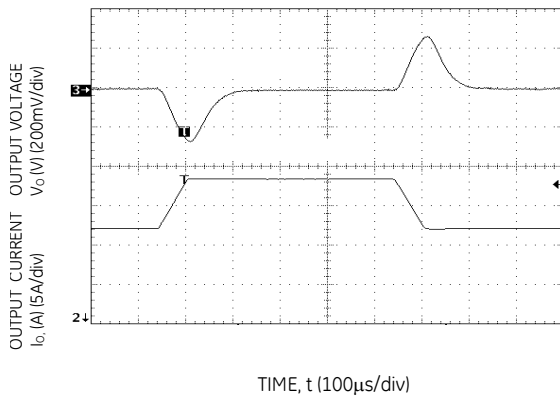

Figure 9. Typical Transient Response to Dynamic Load change Load from 50% to 75% to 50% of Full load at 48 Vdc Input.

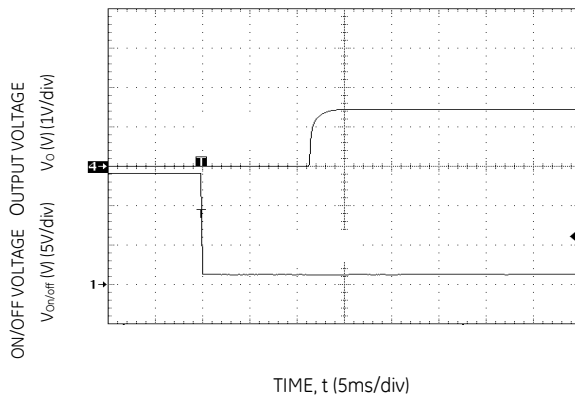

Figure 12. Typical Start-Up Using Remote On/Off, negative logic version shown (Vin = 48Vdc, Io = 25A).

EQW012/020/023/025 Series, Eighth-Brick Power Modules

36 - 75Vdc Input; 1.2Vdc to 5Vdc Output; 12A to 25A Output

Characteristic Curves (continued)

The following figures provide typical characteristics for the EQW025A0Y (1.8V, 25A) at 25°C. The figures are identical for either positive or negative Remote On/Off logic.

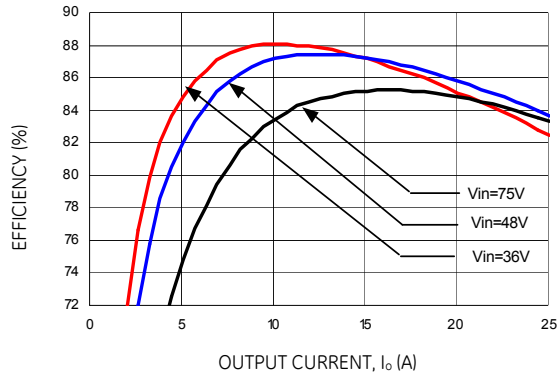

Figure 13. Typical Converter Efficiency Vs. Output current at Room Temperature.

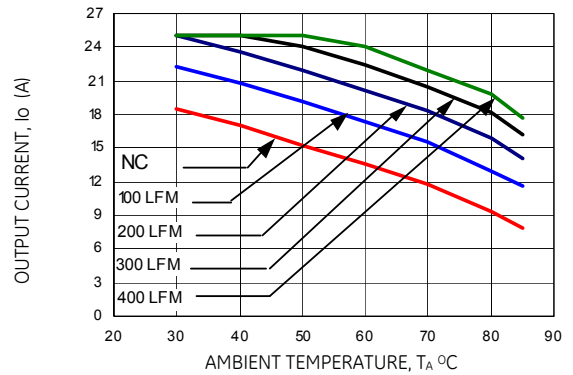

Figure 16. Derating Output Current versus Local Ambient Temperature and Airflow

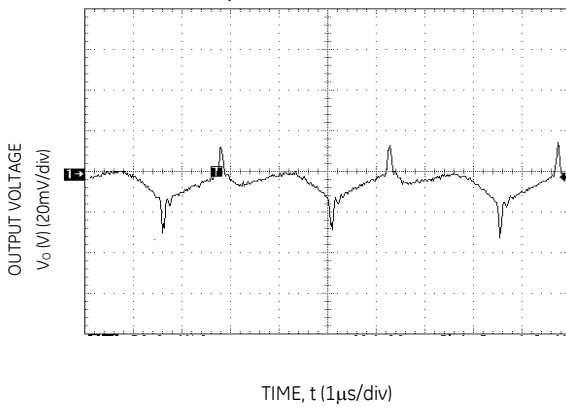

Figure 14. Typical Output Ripple and Noise (Vin =48Vdc, Io = 25A).

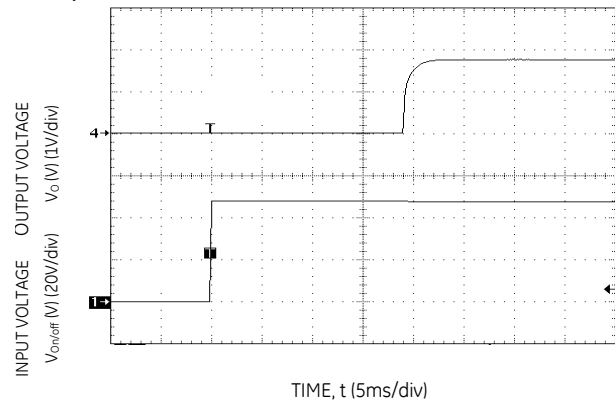

Figure 17. Typical Start-Up with application of Vin (Vin = 48Vdc, Io = 25A).

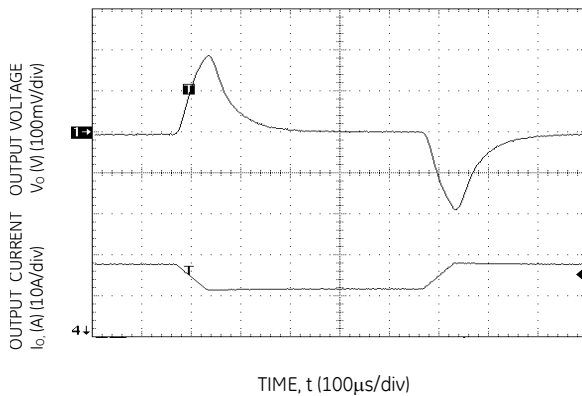

Figure 15. Typical Transient Response to Dynamic Load change Load from 50% to 75% to 50% of Full load at 48 Vdc Input.

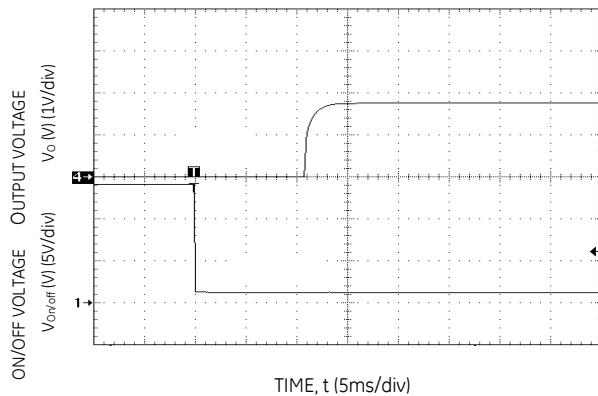

Figure 18. Typical Start-Up Using Remote On/Off, negative logic version shown (Vin = 48Vdc, Io = 25A).

EQW012/020/023/025 Series, Eighth-Brick Power Modules

36 - 75Vdc Input; 1.2Vdc to 5Vdc Output; 12A to 25A Output

Characteristic Curves (continued)

The following figures provide typical characteristics for the EQW023A0G (2.5V, 23A) at 25°C. The figures are identical for either positive or negative Remote On/Off logic.

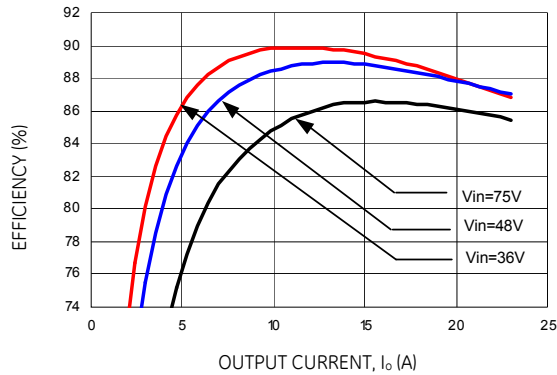

Figure 19. Typical Converter Efficiency Vs. Output current at Room Temperature.

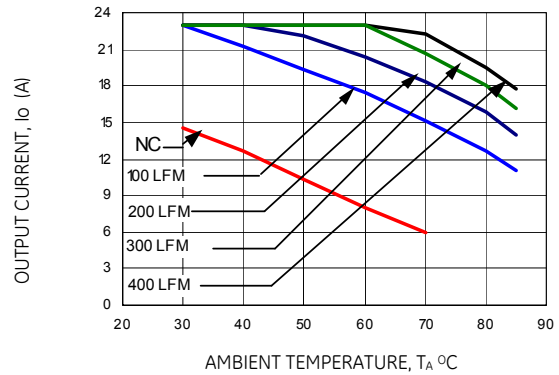

Figure 22. Derating Output Current versus Local Ambient Temperature and Airflow

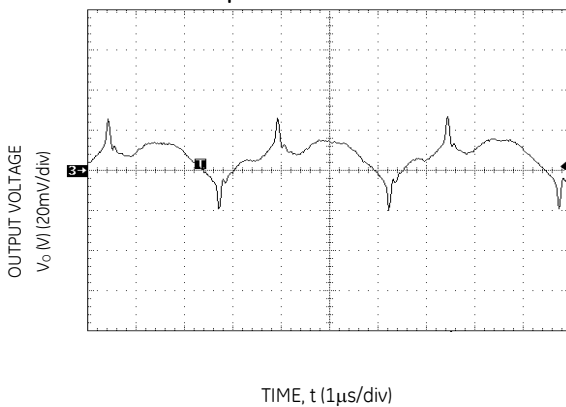

Figure 20. Typical Output Ripple and Noise (Vin =48Vdc, Io = 23A).

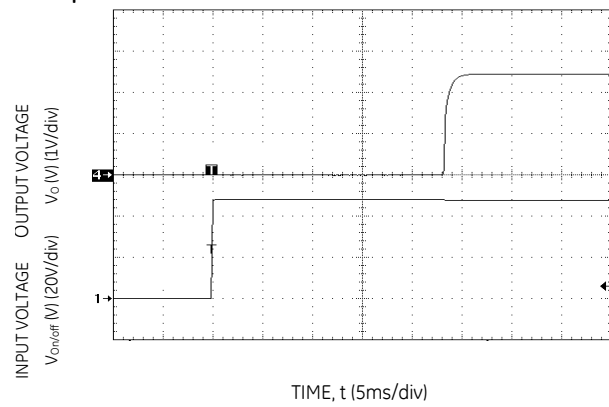

Figure 23. Typical Start-Up with application of Vin (Vin = 48Vdc, Io = 23A).

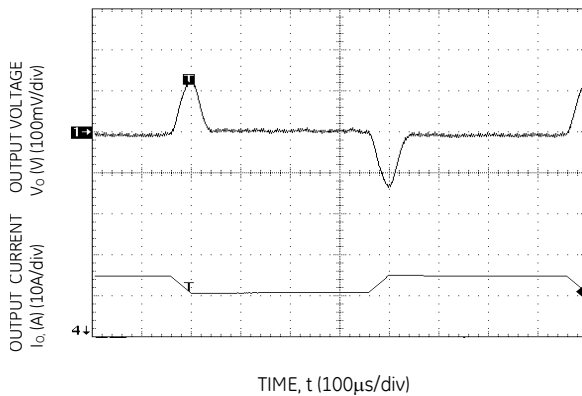

Figure 21. Typical Transient Response to Dynamic Load change Load from 50% to 75% to 50% of Full load at 48 Vdc Input.

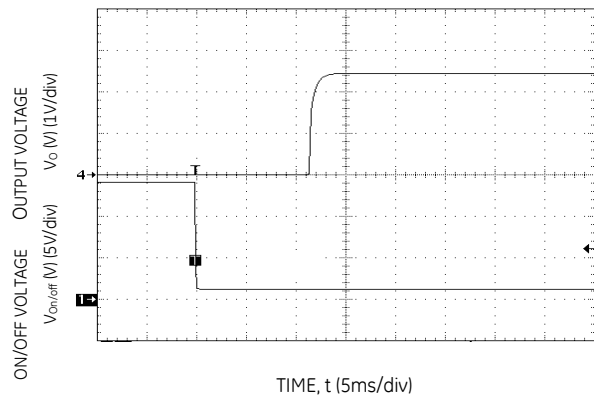

Figure 24. Typical Start-Up Using Remote On/Off, negative logic version shown (Vin = 48Vdc, Io = 23A).

EQW012/020/023/025 Series, Eighth-Brick Power Modules

36 - 75Vdc Input; 1.2Vdc to 5Vdc Output; 12A to 25A Output

Characteristic Curves (continued)

The following figures provide typical characteristics for the EQW020A0F (3.3V, 20A) at 25°C. The figures are identical for either positive or negative Remote On/Off logic.

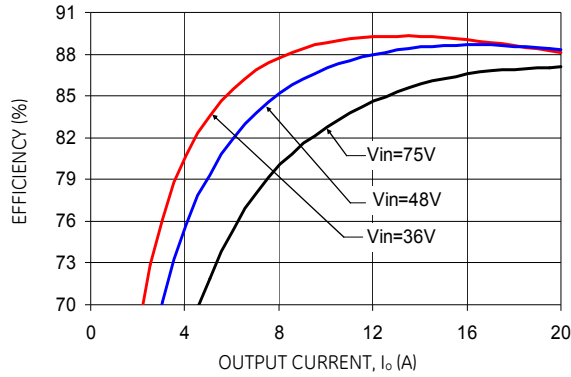

Figure 25. Typical Converter Efficiency Vs. Output current at Room Temperature.

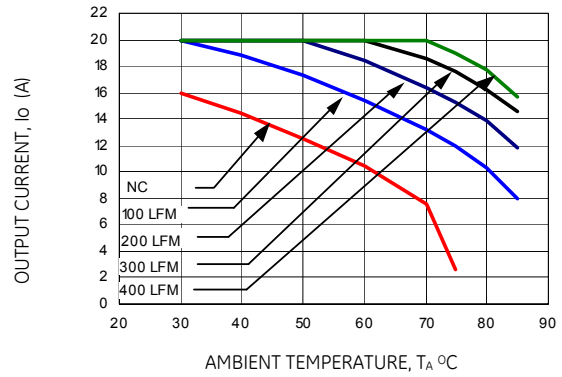

Figure 28. Derating Output Current versus Local Ambient Temperature and Airflow

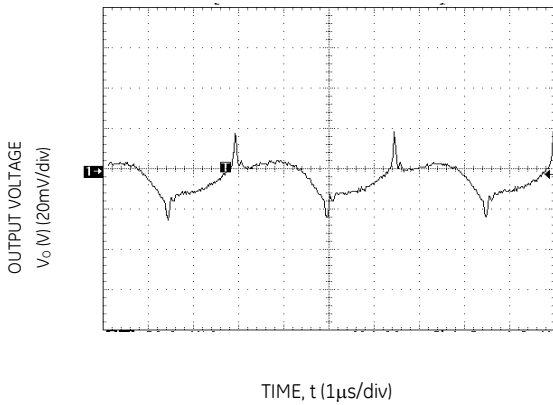

Figure 26. Typical Output Ripple and Noise (Vin =48Vdc, Io = 20A).

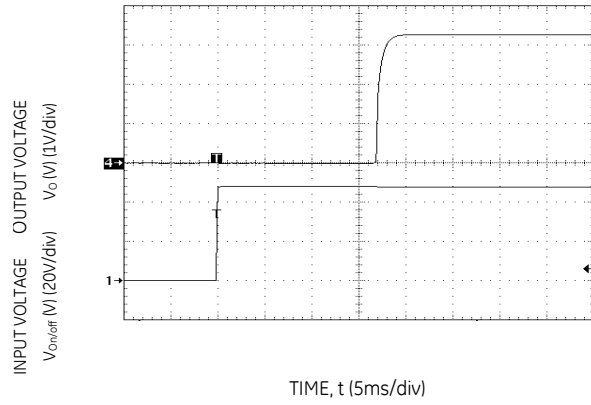

Figure 29. Typical Start-Up with application of Vin (Vin = 48Vdc, Io = 20A).

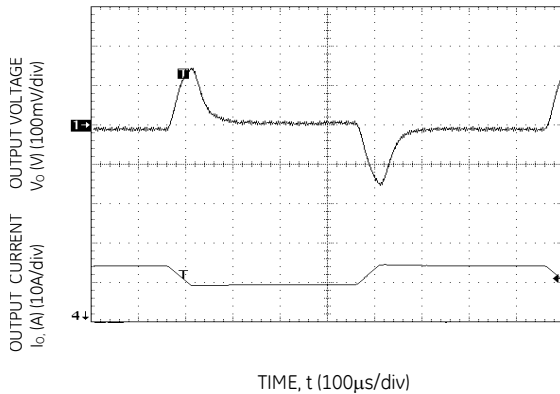

Figure 27. Typical Transient Response to Dynamic Load change Load from 50% to 75% to 50% of Full load at 48 Vdc Input.

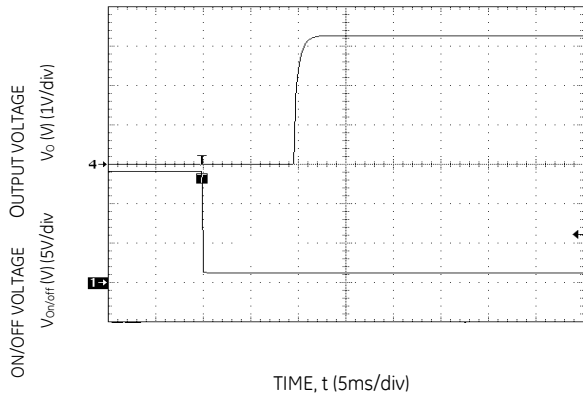

Figure 30. Typical Start-Up Using Remote On/Off, negative logic version shown (Vin = 48Vdc, Io = 20A).

EQW012/020/023/025 Series, Eighth-Brick Power Modules

36 - 75Vdc Input; 1.2Vdc to 5Vdc Output; 12A to 25A Output

Characteristic Curves (continued)

The following figures provide typical characteristics for the EQW012A0A (5.0V, 12A) at 25°C. The figures are identical for either positive or negative Remote On/Off logic.

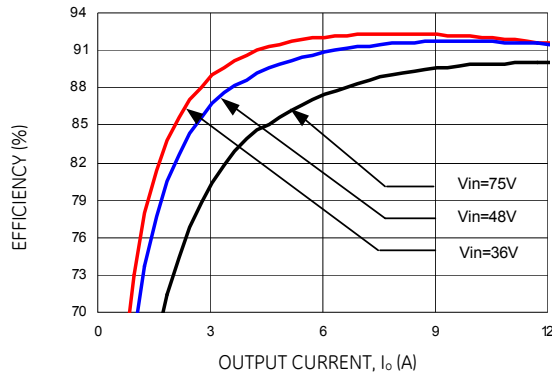

Figure 31. Typical Converter Efficiency Vs. Output current at Room Temperature.

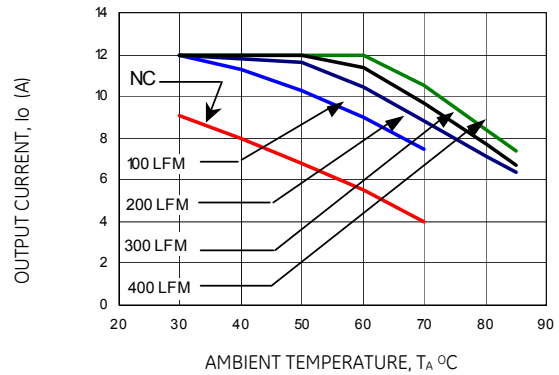

Figure 34. Derating Output Current versus Local Ambient Temperature and Airflow

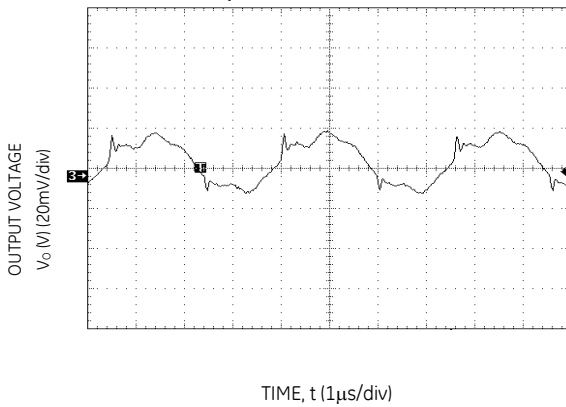

Figure 32. Typical Output Ripple and Noise (Vin =48Vdc, I_o = 12A).

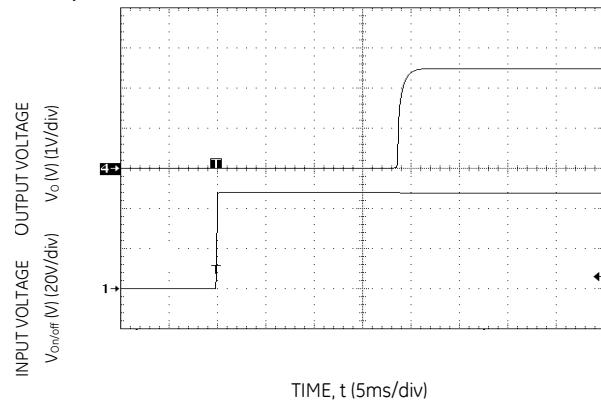

Figure 35. Typical Start-Up with application of Vin (Vin = 48Vdc, I_o = 12A).

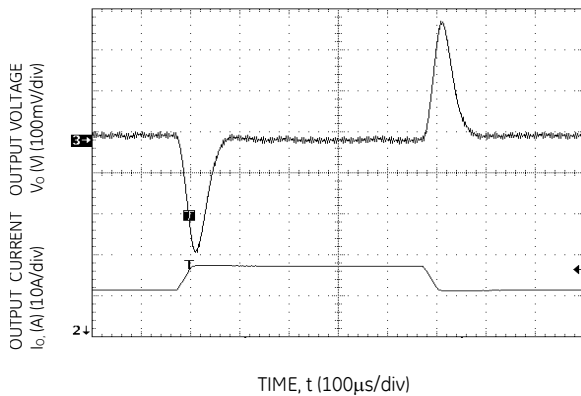

Figure 33. Typical Transient Response to Dynamic Load change Load from 50% to 75% to 50% of Full load at 48 Vdc Input.

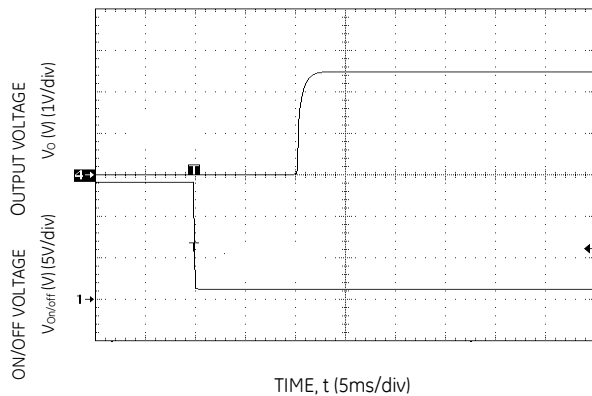
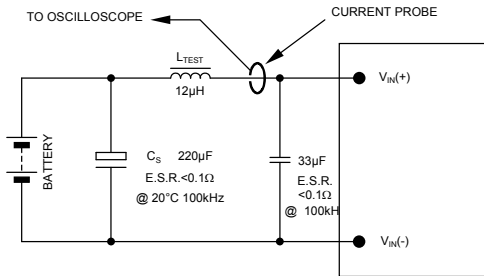

Figure 36. Typical Start-Up Using Remote On/Off, negative logic version shown (Vin = 48Vdc, I_o = 12A).

EQW012/020/023/025 Series, Eighth-Brick Power Modules

36 - 75Vdc Input; 1.2Vdc to 5Vdc Output; 12A to 25A Output

Test Configurations



NOTE: Measure input reflected ripple current with a simulated source inductance (L_{TEST}) of 12µH. Capacitor C_S offsets possible battery impedance. Measure current as shown above.

Figure 37. Input Reflected Ripple Current Test Setup.

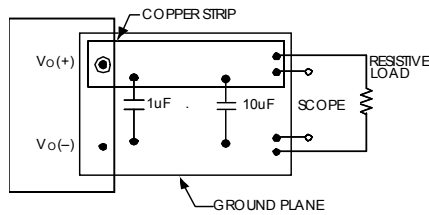

NOTE: All voltage measurements to be taken at the module terminals, as shown above. If sockets are used then Kelvin connections are required at the module terminals to avoid measurement errors due to socket contact resistance.

Figure 38. Output Ripple and Noise Test Setup.

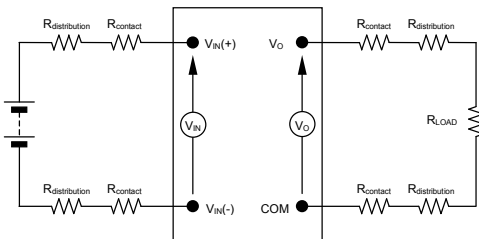

NOTE: All voltage measurements to be taken at the module terminals, as shown above. If sockets are used then Kelvin connections are required at the module terminals to avoid measurement errors due to socket contact resistance.

Figure 39. Output Voltage and Efficiency Test Setup.

$$\text{Efficiency } \eta = \frac{V_o \cdot I_o}{V_{IN} \cdot I_{IN}} \times 100 \%$$

Design Considerations

The power module should be connected to a low ac-impedance source. A highly inductive source impedance can affect the stability of the power module. For the test configuration in Figure 37, a 33µF electrolytic capacitor (ESR<0.7Ω at 100kHz), mounted close to the power module helps ensure the stability of the unit. Consult the factory for further application guidelines.

Safety Considerations

For safety-agency approval of the system in which the power module is used, the power module must be installed in compliance with the spacing and separation requirements of the end-use safety agency standard, i.e., UL60950-1, CSA C22.2 No. 60950-1-03 and VDE 0805 (IEC60950, 3rd Ed).

These converters have been evaluated to the spacing requirements for Basic Insulation, per the above safety standards; and 1500Vdc is applied from V_{in} to V_{out} to 100% of outgoing production..

For end products connected to -48V dc, or -60Vdc nominal DC MAINS (i.e. central office dc battery plant), no further fault testing is required. *Note: -60V dc nominal battery plants are not available in the U.S. or Canada.

For all input voltages, other than DC MAINS, where the input voltage is less than 60V dc, if the input meets all of the requirements for SELV, then:

- The output may be considered SELV. Output voltages will remain within SELV limits even with internally-generated non-SELV voltages. Single component failure and fault tests were performed in the power converters.
- One pole of the input and one pole of the output are to be grounded, or both circuits are to be kept floating, to maintain the output voltage to ground voltage within ELV or SELV limits.

For all input sources, other than DC MAINS, where the input voltage is between 60 and 75V dc (Classified as TNV-2 in Europe), the following must be adhered to, if the converter's output is to be evaluated for SELV:

- The input source is to be provided with reinforced insulation from any hazardous voltage, including the AC mains.
- One V_i pin and one V_o pin are to be reliably earthed, or both the input and output pins are to be kept floating.
- Another SELV reliability test is conducted on the whole system, as required by the safety agencies, on the combination of supply source and the subject module to verify that under a single fault, hazardous voltages do not appear at the module's output.

The power module has ELV (extra-low voltage) outputs when all inputs are ELV.

All flammable materials used in the manufacturing of these modules are rated 94V-0, and UL60950 A.2 for reduced thickness. The input to these units is to be provided with a maximum 6A time- delay in the unearthed lead.

EQW012/020/023/025 Series, Eighth-Brick Power Modules

36 - 75Vdc Input; 1.2Vdc to 5Vdc Output; 12A to 25A Output

Feature Description

Remote On/Off

Two remote on/off options are available. Positive logic turns the module on during a logic high voltage on the ON/OFF pin, and off during a logic low. Negative logic remote On/Off, device code suffix "1", turns the module off during a logic high and on during a logic low.

To turn the power module on and off, the user must supply a switch (open collector or equivalent) to control the voltage ($V_{on/off}$) between the ON/OFF terminal and the $V_{IN}(-)$ terminal (Figure 40). Logic low is $-0.7V \leq V_{on/off} \leq 1.2V$. The maximum $I_{on/off}$ during a logic low is 1mA, the switch should be maintain a logic low level while sinking this current.

During a logic high, the typical $V_{on/off}$ generated by the module is 15V, and the maximum allowable leakage current at $V_{on/off} = 15V$ is 10 μ A.

If not using the remote on/off feature:

For positive logic, leave the ON/OFF pin open.

For negative logic, short the ON/OFF pin to $V_{IN}(-)$.

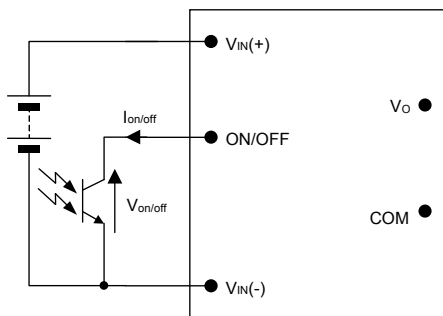

Figure 40. Circuit configuration for using Remote On/Off Implementation.

Remote Sense

Remote sense minimizes the effects of distribution losses by regulating the voltage at the remote-sense connections (See Figure 41). The voltage between the remote-sense pins and the output terminals must not exceed the output voltage sense range given in the Feature Specifications table:

$$[V_O(+)-V_O(-)]-[SENSE(+)-SENSE(-)] \leq 0.5V$$

Although the output voltage can be increased by both the remote sense and by the trim, the maximum increase for the output voltage is not the sum of both. The maximum increase is the larger of either the remote sense or the trim.

The amount of power delivered by the module is defined as the voltage at the output terminals multiplied by the

output current. When using remote sense and trim, the output voltage of the module can be increased, which at the same output current would increase the power output of the module. Care should be taken to ensure that the maximum output power of the module remains at or below the maximum rated power (Maximum rated power = $V_{O,set} \times I_{O,max}$).

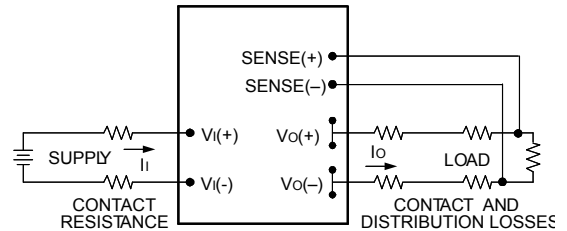

Figure 41. Effective Circuit Configuration for remote sense operation.

Output Voltage Set-Point Adjustment (Trim)

Trimming allows the output voltage set point to be increased or decreased, this is accomplished by connecting an external resistor between the TRIM pin and either the $V_O(+)$ pin or the $V_O(-)$ pin (COM pin).

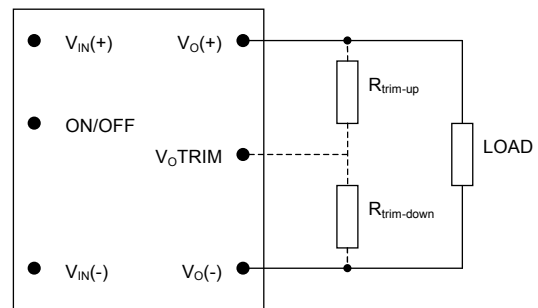

Figure 42. Circuit Configuration to Trim Output Voltage.

Connecting an external resistor ($R_{trim-down}$) between the TRIM pin and the $V_O(-)$ (or Sense(-)) pin decreases the output voltage set point. To maintain set point accuracy, the trim resistor tolerance should be $\pm 0.1\%$.

The following equation determines the required external resistor value to obtain a percentage output voltage change of $\Delta\%$

EQW012/020/023/025 Series, Eighth-Brick Power Modules

36 - 75Vdc Input; 1.2Vdc to 5Vdc Output; 12A to 25A Output

Feature Description (Continued)

Output Voltage Set-Point Adjustment (Trim)
(Continued)

For output voltage: 1.2 V to 12V

$$R_{trim-down} = \left[\frac{510}{\Delta\%} - 10.2 \right] \text{K}\Omega$$

Where

$$\Delta\% = \left(\frac{V_{o,set} - V_{desired}}{V_{o,set}} \right) \times 100$$

For example, to trim-down the output voltage of 2.5V module (EQW023A0G1) by 8% to 2.3V, $R_{trim-down}$ is calculated as follows:

$$\Delta\% = 8$$

$$R_{trim-down} = \left[\frac{510}{8} - 10.2 \right] \text{K}\Omega$$

$$R_{trim-down} = 53.55 \text{K}\Omega$$

Connecting an external resistor ($R_{trim-up}$) between the TRIM pin and the $V_o(+)$ (or Sense (+)) pin increases the output voltage set point. The following equations determine the required external resistor value to obtain a percentage output voltage change of $\Delta\%$:

For output voltage: 1.5 V to 12V

$$R_{trim-up} = \left[\frac{5.1 \times V_{o,set} \times (100 + \Delta\%)}{1.225 \times \Delta\%} - \frac{510}{\Delta\%} - 10.2 \right] \text{K}\Omega$$

For output voltage: 1.2

$$R_{trim-up} = \left[\frac{5.1 \times V_{o,set} \times (100 + \Delta\%)}{0.6 \times \Delta\%} - \frac{510}{\Delta\%} - 10.2 \right] \text{K}\Omega$$

Where

$$\Delta\% = \left(\frac{V_{desired} - V_{o,set}}{V_{o,set}} \right) \times 100$$

For example, to trim-up the output voltage of 1.5V module (EQW025A0M1) by 6% to 1.59V, $R_{trim-up}$ is calculated as follows:

$$\Delta\% = 6$$

$$R_{trim-up} = \left[\frac{5.1 \times 1.5 \times (100 + 6)}{1.225 \times 6} - \frac{510}{6} - 10.2 \right] \text{K}\Omega$$

$$R_{trim-up} = 15.12 \text{K}\Omega$$

Alternative voltage programming for output voltage:
1.2V (-V Option)

An alternative set of trimming equations is available as an option for 1.0V and 1.2V output modules, by ordering the -V option. These equations will reduce the resistance of the external programming resistor, making the impedance into the module trim pin lower for applications in high electrical noise applications.

$$R_{trim-down} = \left[\frac{100}{\Delta\%} - 2 \right] \text{K}\Omega$$

$$R_{trim-up} = \left[\frac{100}{\Delta\%} \right] \text{K}\Omega$$

Where $\Delta\% = \left(\frac{V_{desired} - V_{o,set}}{V_{o,set}} \right) \times 100$

For example, to trim-up the output voltage of 1.2V module (EQW025A0P/P1-V) by 5% to 1.26V, $R_{trim-up}$ is calculated as follows:

$$\Delta\% = 5$$

$$R_{trim-up} = \left[\frac{100}{5} \right] \text{K}\Omega$$

$$R_{trim-up} = 20.0 \text{K}\Omega$$

The value of the external trim resistor for the optional -V 1.2V module is only 20% of the value required with the standard trim equations.

At 48Vin (+/- 2.5V), EQW series modules can be trim down to 20% over the entire temperature range. This allows for margining the unit during manufacturing process if the set point voltage is lower than the standard output voltage. Please consult your local GE field application engineer for additional details.

The voltage between the $V_o(+)$ and $V_o(-)$ terminals must not exceed the minimum output overvoltage protection value shown in the Feature Specifications table. This limit includes any increase in voltage due to remote-sense compensation and output voltage set-point adjustment trim.

Although the output voltage can be increased by both the remote sense and by the trim, the maximum increase for the output voltage is not the sum of both. The maximum increase is the larger of either the remote sense or the trim. The amount of power delivered by the module is defined as the voltage at the output terminals multiplied by the output current. When using remote sense and trim, the output voltage of the module can be increased, which at the same output current would increase the power output of the module. Care should be taken to ensure that the maximum output power of the module remains at or below the maximum rated power (Maximum rated power = $V_{o,set} \times I_{o,max}$).

EQW012/020/023/025 Series, Eighth-Brick Power Modules

36 - 75Vdc Input; 1.2Vdc to 5Vdc Output; 12A to 25A Output

Feature Description (Continued)

Overcurrent Protection

To provide protection in a fault (output overload) condition, the module is equipped with internal current-limiting circuitry, and can endure current limiting continuously. At the instance of current-limit inception, the output current begins to tail-out. When an overcurrent condition exists beyond a few seconds, the module enters a “hiccup” mode of operation, whereby it shuts down and automatically attempts to restart upon cooling. While the fault condition exists, the module will remain in this hiccup mode, and can remain in this mode until the fault is cleared. The unit operates normally once the output current is reduced back into its specified range.

Output Over Voltage Protection

The output overvoltage protection clamp consists of control circuitry, independent of the primary regulation loop, that monitors the voltage on the output terminals. This control loop has a higher voltage set point than the primary loop (See the overvoltage clamp values in the Feature Specifications Table). In a fault condition, the overvoltage clamp ensures that the output voltage does not exceed $V_{o,ovsd, max}$. This provides a redundant voltage-control that reduces the risk of output overvoltage.

Input Undervoltage Lockout

At input voltages below the input undervoltage lockout limit, the module operation is disabled. The module will begin to operate at an input voltage between the undervoltage lockout limit and the minimum operating input voltage.

Overtemperature Protection

To provide protection under certain fault conditions, the unit is equipped with a thermal shutdown circuit. The unit will shutdown if the thermal reference point T_{ref} (Figure 43), exceeds 125°C (typical), but the thermal shutdown is not intended as a guarantee that the unit will survive temperatures beyond its rating. The module will automatically restarts after it cools down.

Thermal Considerations

The power modules operate in a variety of thermal environments; however, sufficient cooling should be provided to help ensure reliable operation.

Considerations include ambient temperature, airflow, module power dissipation, and the need for increased reliability. A reduction in the operating temperature of the module will result in an increase in reliability. The thermal data presented here is based on physical measurements taken in a wind tunnel.

The thermal reference point, T_{ref} used in the specifications is shown in Figure 43. For reliable

operation this temperature should not exceed 115 °C. The output power of the module should not exceed the rated power for the module ($V_o, set \times I_o, max$).

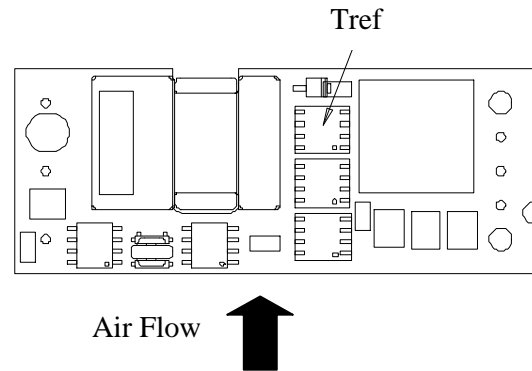

Figure 43. T_{ref} Temperature Measurement Location.

Please refer to the Application Note “Thermal Characterization Process For Open-Frame Board-Mounted Power Modules” for a detailed discussion of thermal aspects including maximum device temperatures.

Heat Transfer via Convection

Increased airflow over the module enhances the heat transfer via convection. Derating figures showing the maximum output current that can be delivered by each module versus local ambient temperature (T_A) for natural convection and up to 2m/s (400 ft./min) are shown in the respective Characteristics Curves section.

EQW012/020/023/025 Series, Eighth-Brick Power Modules

36 - 75Vdc Input; 1.2Vdc to 5Vdc Output; 12A to 25A Output

EMC Considerations

The figure 44 shows a suggested configuration to meet the conducted emission limits of EN55022 Class B.

Copper paths must not be routed beneath the power module mounting inserts. Recommended SMT layout shown in the mechanical section are for reference only. SMT layout depends on the end PCB configuration and the location of the load. For additional layout guide-lines, refer to FLTR100V10 data sheet or contact your local GE field application engineer.

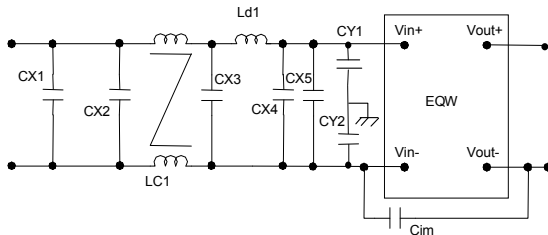

Figure 44. Suggested Input Filter Configuration for EN55022 Class B.

Filter components:

- Cx1: 47uF aluminum electrolytic, 100V (Nichicon PW series)
- Cx2: 2x1uF ceramic, 100V (TDK C4532X7R2A105M)
- Cx3: 2x1uF ceramic, 100V (TDK C4532X7R2A105M)
- Cx4: 2x1uF ceramic, 100V (TDK C4532X7R2A105M)
- Cx5: 100uF aluminum electrolytic, 100V (Nichicon PW series)
- Cy3, Cy4: 3300pF ceramic, 1500V (AVX 1812SC332MAT1A)
- Cim: 3300pF ceramic, 1500V (AVX 1812SC332MAT1A)
- Lc1: 768 uH, 4.7A (Pulse Engineering P0422)
- Ld1: 4.7 uH, 5.5A (Vishay IHLP-2525CZ)

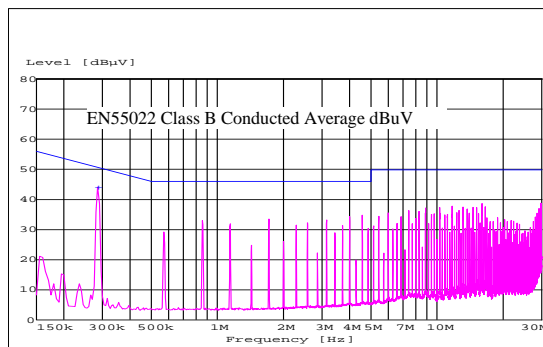

Figure 45. EMC signature using recommended filter.

For further information on designing for EMC compliance, please refer to the FLTR100V10 data sheet (FDS01-043EPS).

Layout Considerations

EQW012/020/023/025 Series, Eighth-Brick Power Modules

36 - 75Vdc Input; 1.2Vdc to 5Vdc Output; 12A to 25A Output

Mechanical Outline for Through-Hole Module

Dimensions are in millimeters and [inches].

Tolerances: x.x mm ± 0.5 mm [x.xx in. ± 0.02 in.] (Unless otherwise indicated)

x.xx mm ± 0.25 mm [x.xxx in. ± 0.010 in.]

Top View

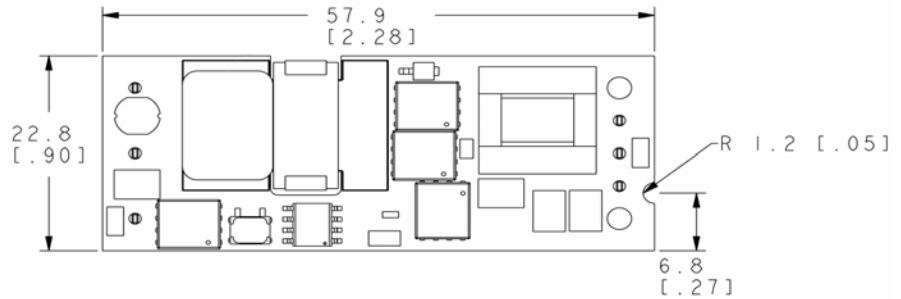

Side View

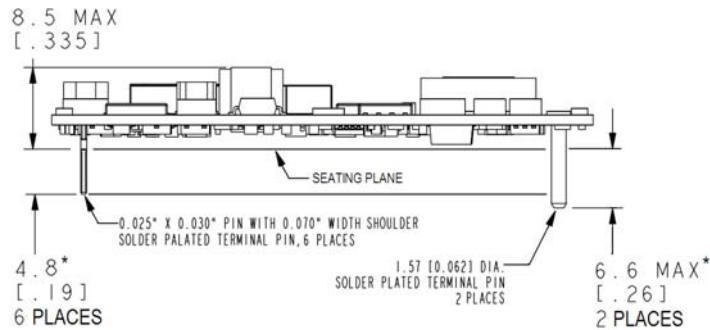

* OPTIONAL PIN LENGTHS SHOWN IN TABLE 2 DEVICE OPTIONS

Bottom View

Pin	Function
1	Vi(+)
2	On/Off
3	Vi(-)
4	Vo(-)
5	Sense(-)
6	Trim
7	Sense(+)
8	Vo(+)

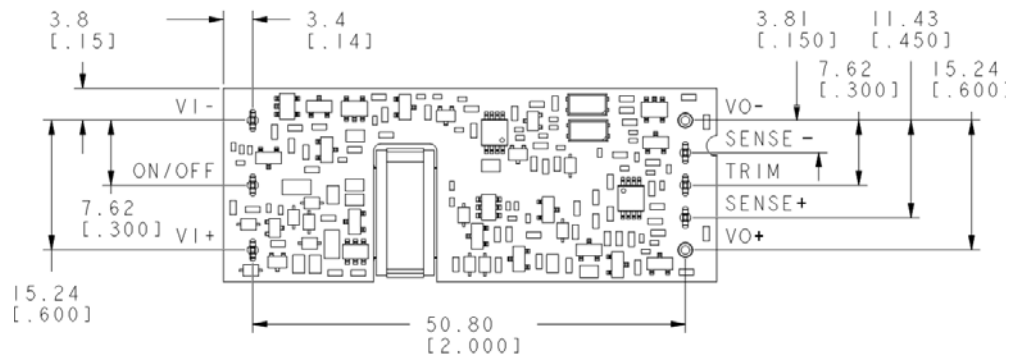

EQW012/020/023/025 Series, Eighth-Brick Power Modules

36 - 75Vdc Input; 1.2Vdc to 5Vdc Output; 12A to 25A Output

Mechanical Outline for Surface Mount Power module.

Dimensions are in millimeters and [inches].

Tolerances: x.x mm ± 0.5 mm [x.xx in. ± 0.02 in.] (Unless otherwise indicated)

x.xx mm ± 0.25 mm [x.xxx in. ± 0.010 in.]

Top View

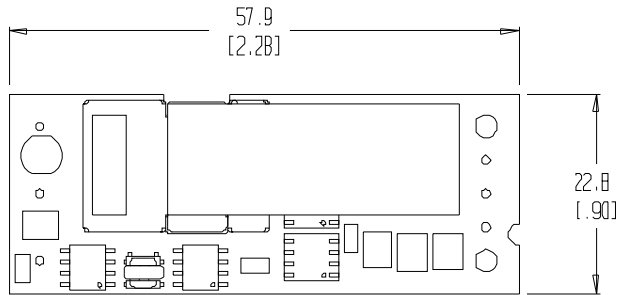

Side View

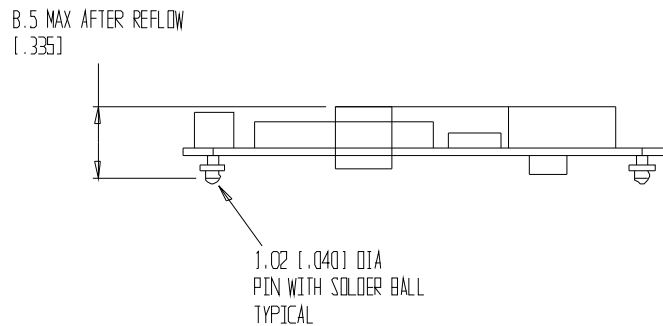

Bottom View

Pin	Function
1	VI(+)
2	On/Off
3	VI(-)
4	Vo(-)
5	Sense(-)
6	Trim
7	Sense(+)
8	Vo(+)

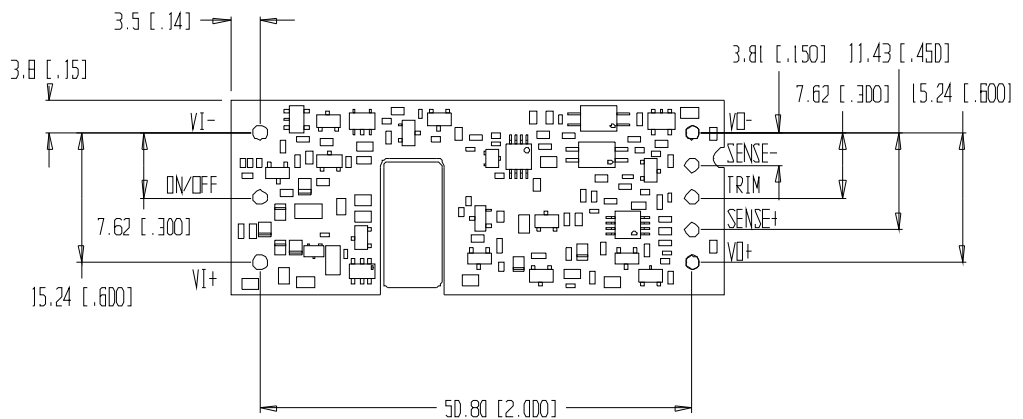

EQW012/020/023/025 Series, Eighth-Brick Power Modules

36 - 75Vdc Input; 1.2Vdc to 5Vdc Output; 12A to 25A Output

Recommended Pad Layout for Surface-Mount Modules

Dimensions are in millimeters and [inches].

Tolerances: x.x mm ± 0.5 mm [x.xx in. ± 0.02 in.] (Unless otherwise indicated)

x.xx mm ± 0.25 mm [x.xxx in. ± 0.010 in.]

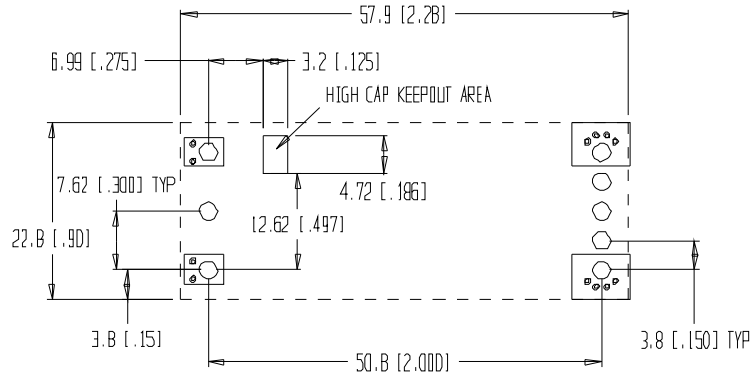

Low Current

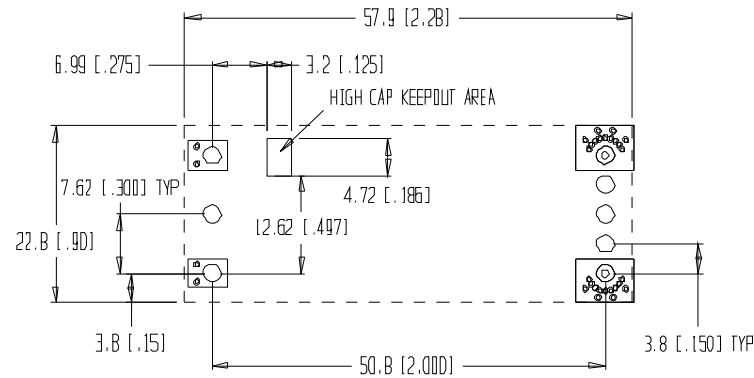

High Current

NOTES:

- FOR EGA SURFACE MOUNT PIN USE THE FOLLOWING PAD

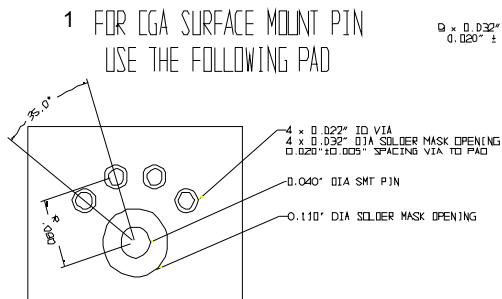

FOR VOUT+ AND VOUT-
LOW CURRENT

- 4 x 0.022° IQ VIA
- 4 x 0.032° DIA SOLDER MASK OPENING
- 0.020° ± 0.005° SPACING VIA TO PAD

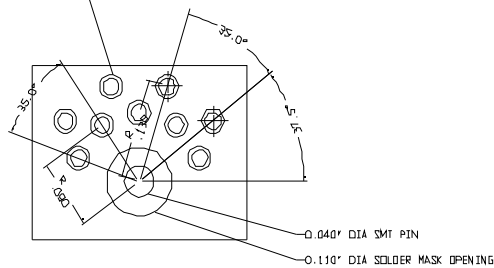

FOR VOUT+ AND VOUT-
HIGH CURRENT

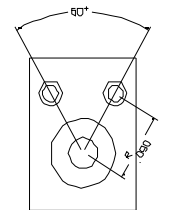

FOR VIN+ AND VIN-

EQW012/020/023/025 Series, Eighth-Brick Power Modules
 36 - 75Vdc Input; 1.2Vdc to 5Vdc Output; 12A to 25A Output

Recommended Pad Layout for Through-Hole modules

Dimensions are in millimeters and [inches].

Tolerances: x.x mm ± 0.5 mm [x.xx in. ± 0.02 in.] (Unless otherwise indicated)

x.xx mm ± 0.25 mm [x.xxx in. ± 0.010 in.]

Component side view

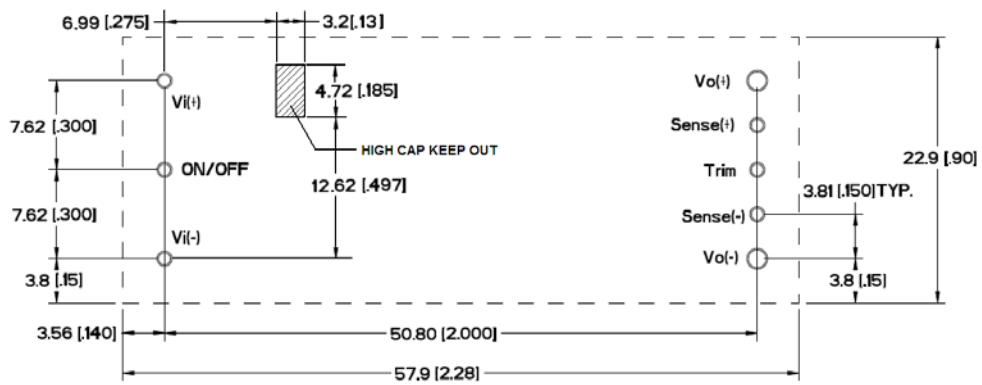

NOTES:

- 1. FOR 0.030"x0.025" PIN
USE 0.050" DIA PLATED THROUGH HOLE
- 2. FOR 0.060" DIA PIN
USE 0.076" DIA PLATED THROUGH HOLE

EQW012/020/023/025 Series, Eighth-Brick Power Modules

36 - 75Vdc Input; 1.2Vdc to 5Vdc Output; 12A to 25A Output

Packaging Details

The surface mount versions of the EQW surface mount modules (suffix -S) are supplied as standard in the plastic tray shown in Figure 46. The tray has external dimensions of 135.1mm (W) x 321.8mm (L) x 12.42mm (H) or 5.319in (W) x 12.669in (L) x 0.489in (H).

Tray Specification

Material	Antistatic coated PVC
Max surface resistivity	$10^{12}\Omega/\text{sq}$
Color	Clear
Capacity	12 power modules
Min order quantity	48 pcs (1box of 4 full trays)

Each tray contains a total of 12 power modules. The trays are self-stacking and each shipping box will contain 4 full trays plus one empty hold down tray giving a total number of 48 power modules.

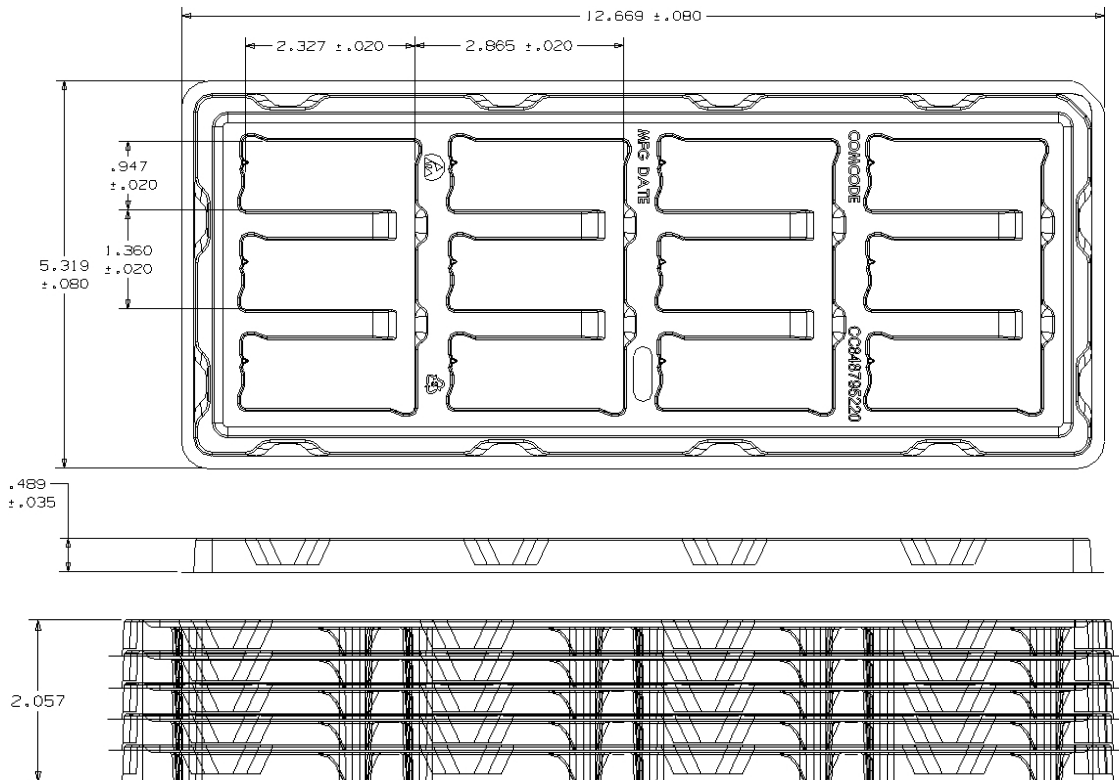

Figure 46. Surface Mount Packaging Tray.

EQW012/020/023/025 Series, Eighth-Brick Power Modules

36 - 75Vdc Input; 1.2Vdc to 5Vdc Output; 12A to 25A Output

Through-Hole Soldering Information

The RoHS-compliant through-hole products use the SAC (Sn/Ag/Cu) Pb-free solder and RoHS-compliant components. They are designed to be processed through single or dual wave soldering machines. The pins have an RoHS-compliant finish that is compatible with both Pb and Pb-free wave soldering processes. A maximum preheat rate of 3°C/s is suggested. The wave preheat process should be such that the temperature of the power module board is kept below 210°C. For Pb solder, the recommended pot temperature is 260°C, while the Pb-free solder pot is 270°C max. Not all RoHS-compliant through-hole products can be processed with paste-through-hole Pb or Pb-free reflow process. If additional information is needed, please consult with your GE representative for more details.

Surface Mount Information

Pick and Place

The SMT versions of the EQW series of DC-to-DC power converters use an open-frame construction and are designed for surface mount assembly within a fully automated manufacturing process.

The EQW-S series modules are fitted with a Kapton label designed to provide a large flat surface for pick and placing. The label is located covering the center of gravity of the power module. The label meets all the requirements for surface-mount processing, as well as meeting UL safety agency standards. The label will withstand reflow temperatures up to 300°C. The label also carries product information such as product code, date and location of manufacture.

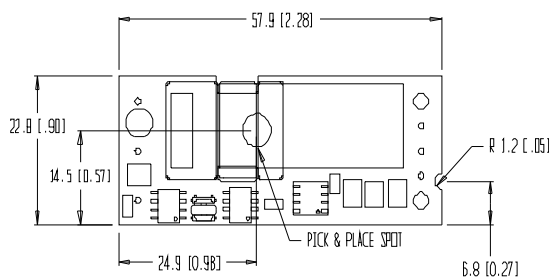

Figure 47. Pick and Place Location.

Z plane Height

The 'Z' plane height of the pick and place label is 9.15 mm (0.360 in) nominal with an RSS tolerance of +/-0.25 mm.

Nozzle Recommendations

The module weight has been kept to a minimum by using open frame construction. Even so, they have a

relatively large mass when compared with conventional smt components. Variables such as nozzle size, tip style, vacuum pressure and placement speed should be considered to optimize this process.

The minimum recommended nozzle diameter for reliable operation is 6mm. The maximum nozzle outer diameter, which will safely fit within the allowable component spacing, is 9 mm. Oblong or oval nozzles up to 11 x 9 mm may also be used within the space available.

For further information please contact your local GE Technical Sales Representative.

Reflow Soldering Information

The surface mountable modules in the EQW family use our newest SMT technology called "Column Pin" (CP) connectors. Figure 48 shows the new CP connector before and after reflow soldering onto the end-board assembly.

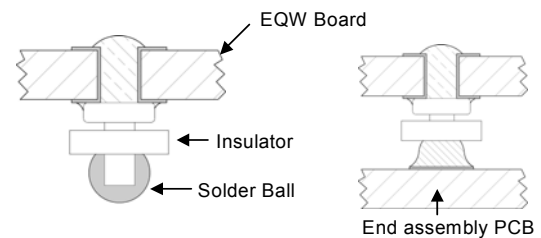

Figure 48. Column Pin Connector Before and After Reflow Soldering .

The CP is constructed from a solid copper pin with an integral solder ball attached, which is composed of tin/lead (Sn₆₃/Pb₃₇) solder for non-Z codes, or Sn/Ag_{3.8}/Cu_{0.7} (SAC) solder for -Z codes. The CP connector design is able to compensate for large amounts of co-planarity and still ensure a reliable SMT solder joint. Typically, the eutectic solder melts at 183°C (Sn/Pb solder) or 217-218 °C (SAC solder), wets the land, and subsequently wicks the device connection. Sufficient time must be allowed to fuse the plating on the connection to ensure a reliable solder joint. There are several types of SMT reflow technologies currently used in the industry. These surface mount power modules can be reliably soldered using natural forced convection, IR (radiant infrared), or a combination of convection/IR.

The following instructions must be observed when SMT soldering these units. Failure to observe these instructions may result in the failure of or cause damage to the modules, and can adversely affect long-term reliability.

EQW012/020/023/025 Series, Eighth-Brick Power Modules

36 - 75Vdc Input; 1.2Vdc to 5Vdc Output; 12A to 25A Output

Surface Mount Information (continued)

Tin Lead Soldering

The recommended linear reflow profile using Sn/Pb solder is shown in Figure 49 and 50. For reliable soldering the solder reflow profile should be established by accurately measuring the modules CP connector temperatures.

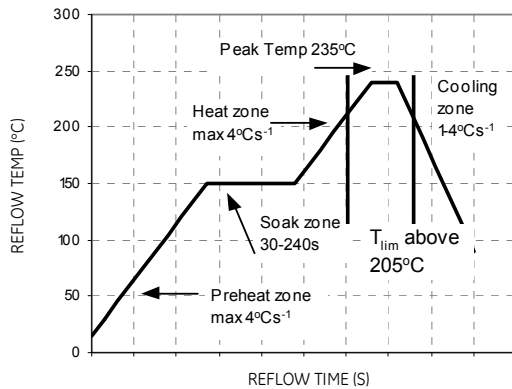

Figure 49. Recommended Reflow Profile for Sn/Pb Solder.

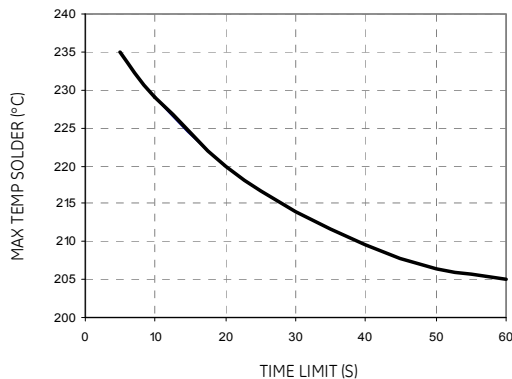

Figure 50. Time Limit, T_{lim} , Curve Above 205°C Reflow .

Lead Free Soldering

The -Z version SMT modules of EQW series are lead-free (Pb-free) and RoHS compliant and are compatible in a Pb-free soldering process. Failure to observe the instructions below may result in the failure of or cause damage to the modules and can adversely affect long-term reliability.

Pb-free Reflow Profile

Power Systems will comply with J-STD-020 Rev. D (Moisture/Reflow Sensitivity Classification for Nonhermetic Solid State Surface Mount Devices) for both

Pb-free solder profiles and MSL classification procedures. This standard provides a recommended forced-air-convection reflow profile based on the volume and thickness of the package (table 4-2). The suggested Pb-free solder paste is Sn/Ag/Cu (SAC). The recommended linear reflow profile using Sn/Ag/Cu solder is shown in Fig. 51.

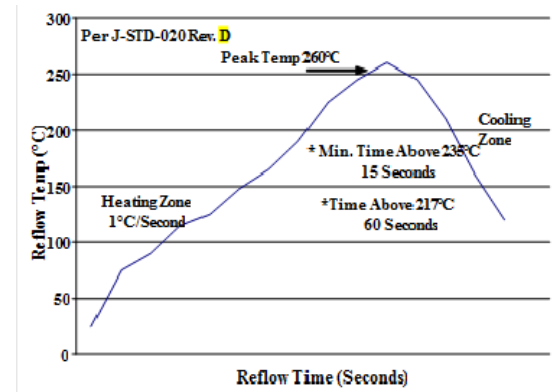

Figure 51. Recommended linear reflow profile using Sn/Ag/Cu solder.

MSL Rating

The EQW series SMT modules have a MSL rating of 2a.

Storage and Handling

The recommended storage environment and handling procedures for moisture-sensitive surface mount packages is detailed in J-STD-033 Rev. A (Handling, Packing, Shipping and Use of Moisture/Reflow Sensitive Surface Mount Devices). Moisture barrier bags (MBB) with desiccant are required for MSL ratings of 2 or greater. These sealed packages should not be broken until time of use. Once the original package is broken, the floor life of the product at conditions of $\leq 30^{\circ}\text{C}$ and 60% relative humidity varies according to the MSL rating (see J-STD-033A). The shelf life for dry packed SMT packages will be a minimum of 12 months from the bag seal date, when stored at the following conditions: $< 40^{\circ}\text{C}$, $< 90\%$ relative humidity.

Post Solder Cleaning and Drying Considerations

Post solder cleaning is usually the final circuit-board assembly process prior to electrical board testing. The result of inadequate cleaning and drying can affect both the reliability of a power module and the testability of the finished circuit-board assembly. For guidance on appropriate soldering, cleaning and drying procedures, refer to *GE Board Mounted Power Modules: Soldering and Cleaning Application Note (AN04-001)*.

EQW012/020/023/025 Series, Eighth-Brick Power Modules

36 - 75Vdc Input; 1.2Vdc to 5Vdc Output; 12A to 25A Output

Ordering Information

Please contact your GE Sales Representative for pricing, availability and optional features.

Table 1. Device Codes

Product codes	Input Voltage	Output Voltage	Output Current	Efficiency	Connector Type	Comcodes
EQW012A0A1	48V (36-75Vdc)	5.0 V	12 A	91.0 %	Through hole	108984444
EQW012A0A61	48V (36-75Vdc)	5.0 V	12 A	91.0 %	Through hole	108990280
EQW012A0A81	48V (36-75Vdc)	5.0 V	12 A	91.0 %	Through hole	108991650
EQW012A0A1Z	48V (36-75Vdc)	5.0 V	12 A	91.0 %	Through hole	CC109104972
EQW012A0A6Z	48V (36-75Vdc)	5.0 V	12 A	91.0 %	Through hole	CC109131570
EQW012A0A1-S	48V (36-75Vdc)	5.0 V	12 A	91.0 %	SMT	108980889
EQW012A0A1-SZ	48V (36-75Vdc)	5.0 V	12 A	91.0 %	SMT	109100162
EQW020A0F	48V (36-75Vdc)	3.3 V	20 A	88.0 %	Through hole	108979428
EQW020A0F1	48V (36-75Vdc)	3.3 V	20 A	88.0 %	Through hole	108981952
EQW020A0F1Z	48V (36-75Vdc)	3.3 V	20 A	88.0 %	Through hole	CC109107050
EQW020A0F61	48V (36-75Vdc)	3.3 V	20 A	88.0 %	Through hole	108985698
EQW020A0F61Z	48V (36-75Vdc)	3.3 V	20 A	88.0 %	Through hole	CC109101796
EQW020A0F61-13	48V (36-75Vdc)	3.3 V	20 A	88.0 %	Through hole	CC109136710
EQW020A0F8Z	48V (36-75Vdc)	3.3 V	20 A	88.0 %	Through hole	CC109150455
EQW020A0F1-S	48V (36-75Vdc)	3.3 V	20 A	88.0 %	SMT	108980905
EQW020A0F1-SZ	48V (36-75Vdc)	3.3 V	20 A	88.0 %	SMT	109100170
EQW023A0G1	48V (36-75Vdc)	2.5V	23 A	87.0 %	Through hole	108980624
EQW023A0G1-S	48V (36-75Vdc)	2.5V	23 A	87.0 %	SMT	108980921
EQW025A0Y61	48V (36-75Vdc)	1.8 V	25 A	84.0 %	Through hole	CC109107091
EQW025A0Y61Z	48V (36-75Vdc)	1.8 V	25 A	84.0 %	Through hole	108985706
EQW025A0Y1Z	48V (36-75Vdc)	1.8 V	25 A	84.0 %	Through hole	CC109138913
EQW025A0M61	48V (36-75Vdc)	1.5 V	25 A	81.0 %	Through hole	108985714
EQW025A0M1Z	48V (36-75Vdc)	1.5 V	25 A	81.0 %	Through hole	CC109107067
EQW025A0P1Z	48V (36-75Vdc)	1.2 V	25 A	81.0 %	Through hole	CC109107083
EQW025A0P1-SZ	48V (36-75Vdc)	1.2 V	25 A	81.0 %	SMT	109100187

EQW012/020/023/025 Series, Eighth-Brick Power Modules

36 - 75Vdc Input; 1.2Vdc to 5Vdc Output; 12A to 25A Output

Table 2. Device Options

Option	Suffix*
Negative remote on/off logic	1
Short Pins: 3.68 mm ± 0.25 mm (0.145 in ±0.010 in)	6
Short Pins: 2.79 mm ± 0.25 mm (0.110 in ±0.010 in)	8
Surface mount connections	-S
Alternative Voltage Programming equations (1.0V and 1.2V modules only)	-V
RoHS Compliant	-Z

*Note: Legacy device codes may contain a -B option suffix to indicate 100% factory Hi-Pot tested to the isolation voltage specified in the Absolute Maximum Ratings table. The 100% Hi-Pot test is now applied to all device codes, with or without the -B option suffix. Existing comcodes for devices with the -B suffix are still valid; however, no new comcodes for devices containing the -B suffix will be created.

Contact Us

For more information, call us at

USA/Canada:

+1 877 546 3243, or +1 972 244 9288

Asia-Pacific:

+86.021.54279977*808

Europe, Middle-East and Africa:

+49.89.878067-280



imagination at work

www.gecriticalpower.com

GE Critical Power reserves the right to make changes to the product(s) or information contained herein without notice, and no liability is assumed as a result of their use or application. No rights under any patent accompany the sale of any such product(s) or information.